



# VISUAL DISPLAYS

BUYER'S GUIDE



2023



## CONTENTS

Poster Holder "Classic" Range	pg 02
Poster Holder "Anti-Shock" Range	pg 03
Poster Holder "Premium" Range	pg 04
Poster Holder "Glass-Look" Range	pg 05
Poster Holder "Upright" Range	pg 06
Label Holders	pg 07
Magnetic Frames	pg 08 - 10
Colored Base Menu Stand	pg 11
Wood Mix Visual Holders	pg 12 - 13
Wood Mix Holders	pg 14
Aluminium Base Visual Holders	pg 15
Menu Holders	pg 16-20
Information Frames	pg 21 - 22
Poster Pockets / Sleeves	pg 23 - 26
Write-on Range	pg 27 - 28
Injection Range	pg 29 - 30
Leaflet Holders	pg 31
Leaflet Dispenser / Floor Stand	pg 32
Presentation Displays	pg 33
Suggestion / Donation Boxes	pg 34 - 35
Product Holders / Easels	pg 36
Presentation Boxes	pg 37
Dump Bins / Impulse Boxes	pg 38 - 39
Photo Holders	pg 40

## POSTER HOLDER "CLASSIC" RANGE

Our sign holder range is the ideal way to display important information in office settings, receptions and restaurants. These holders are the perfect addition to your shop front, showcase, hostess desk, bar area, or dining room to grab guests' attention and direct them to your products and services. Flyers and any other printed information are easily inserted into the holder for a professional look in the lobby, shop or reception area of your office. Our range of sizes allows you to place different paper formats straight from your printer into the display easel without the hassle of laminating. The self-standing design rests on a sturdy base so you can arrange any of these models on a flat surface without risk of falling over. "Ready to use" no assembly required.

### L-Shaped Visual Holder

- Manufactured in PS with diamond polished edges
- Transparent for optimum visibility of the inserted message
- Slanted for a better poster visibility when used below eye level
- Poster insertion is possible from each side for easy replacement
- Available in smaller formats under "Label Holder" Category

Item Code	Description (Paper Format & Orientation)	Thickness (mm)	Units / Box
SV10040STY	A7 Landscape L-Shaped Poster Holder	1,5	250
SV10390STY	A6 Portrait L-Shaped Poster Holder	1,5	20
SV11878STY	A6 Landscape L-Shaped Poster Holder	1,5	20
SV10085STY	1/3 A4 Portrait L-Shaped Poster Holder	1,5	50
SV10391STY	A5 Portrait L-Shaped Poster Holder	1,5	30
SV11877STY	A5 Landscape L-Shaped Poster Holder	1,5	30
SV10392STY-S	A4 Portrait L-Shaped Poster Holder	1,5	30
SV11876STY-S	A4 Landscape L-Shaped Poster Holder	1,5	30
SV10392STY	A4 Portrait L-Shaped Poster Holder	1,8	30
SV11876STY	A4 Landscape L-Shaped Poster Holder	1,8	30
SV10033STY	A3 Portrait L-Shaped Poster Holder	3	20
SV12177STY	A3 Landscape L-Shaped Poster Holder	3	20



### T-Shaped Visual Holder

- Manufactured in PS with diamond polished edges
- Transparent for optimum visibility of the inserted message
- Double sided for maximum impact and space optimization on all angles
- Poster insertion from each side and bottom for easy replacement

Item Code	Description (Paper Format & Orientation)	Thickness (mm)	Units / Box
SV10800STY	A6 Portrait T-Shaped Poster Holder	1,5	50
SV11881STY	A6 Landscape T-Shaped Poster Holder	1,5	50
SV10801STY	1/3 A4 Portrait T-Shaped Poster Holder	1,5	50
SV10797STY	A5 Portrait T-Shaped Poster Holder	1,5	30
SV11880STY	A5 Landscape T-Shaped Poster Holder	1,5	30
SV10799STY-S	A4 Portrait T-Shaped Poster Holder	1,5	30
SV11879STY-S	A4 Landscape T-Shaped Poster Holder	1,5	30
SV10799STY	A4 Portrait T-Shaped Poster Holder	1,8	30
SV11879STY	A4 Landscape T-Shaped Poster Holder	2	30
SV10802STY	A3 Portrait T-Shaped Poster Holder	3	10
SV11862STY	A3 Landscape T-Shaped Poster Holder	3	10



## POSTER HOLDER "ANTI-SHOCK" RANGE

Our sign holder range is the ideal way to display important information in office settings, receptions and restaurants. These items are a perfect addition to your shop front, showcase, hostess desk or dining room to grab guests' attention and direct to them to your products and services. Flyers and any other printed information are easily inserted into the holder for a professional look in the lobby, shop or reception area of your office. Our range of sizes allows you to place different paper formats straight from your printer into the display easel without the hassle of laminating. The self-standing design rests on a sturdy base so you can arrange any of these models on a flat surface without risk of falling over. "Ready to use" no assembly required.

### L-Shaped Visual Holder

- Manufactured in PET
- Shock resistant; Increased fire resistance; Food contact certified
- Slanted for a better poster visibility when used below eye level
- Available in smaller formats under "Label Holder" Category

Item Code	Description (Paper Format & Orientation)	Thickness (mm)	Units / Box
SV10192PET	A7 Portrait L-Shaped Poster Holder	1	200
SV10040PET	A7 Landscape L-Shaped Poster Holder	1	250
SV10187PET	A6 Portrait L-Shaped Poster Holder	1	100
SV11878PET	A6 Landscape L-Shaped Poster Holder	1	100
SV10085PET	1/3 A4 Portrait L-Shaped Poster Holder	1	50
SV11207PET	A5 Portrait L-Shaped Poster Holder	1	50
SV10195PET	A5 Landscape L-Shaped Poster Holder	1	100
SV11204PET	A4 Portrait L-Shaped Poster Holder	1,5	30
SV10196PET	A4 Landscape L-Shaped Poster Holder	1,5	40
SV10033PET	A3 Portrait L-Shaped Poster Holder	2	20
SV12177PET	A3 Landscape L-Shaped Poster Holder	2	20



### T-Shaped Visual Holder

- Transparent for optimum visibility of the inserted message
- Shock resistant; Increased fire resistance; Food contact certified
- Double sided for maximum impact and space optimization on all angles

Item Code	Description (Paper Format & Orientation)	Thickness (mm)	Units / Box
SV10800PET	A6 Portrait T-Shaped Poster Holder	1	50
SV11881PET	A6 Landscape T-Shaped Poster Holder	1,5	50
SV10801PET	1/3 A4 Portrait T-Shaped Poster Holder	1,5	50
SV10797PET	A5 Portrait T-Shaped Poster Holder	1,5	30
SV11880PET	A5 Landscape T-Shaped Poster Holder	1,5	30
SV10799PET	A4 Portrait T-Shaped Poster Holder	1,5	30
SV11879PET	A4 Landscape T-Shaped Poster Holder	2	30
SV10802PET	A3 Portrait T-Shaped Poster Holder	2	10
SV11862PET	A3 Landscape T-Shaped Poster Holder	3	10



### L-Shaped Visual Holder - "Eco-Range"

- Shock resistant; Increased fire resistance; Food contact certified
- Slanted for a better poster visibility when used below eye level
- Folded back for product cost optimization

Item Code	Description (Paper Format & Orientation)	Thickness (mm)	Units / Box
SV11155PET	A6 Portrait L-Shaped Poster Holder	0,8	20
SV11154PET	A5 Portrait L-Shaped Poster Holder	1	30
SV11153PET	A4 Portrait L-Shaped Poster Holder	1	30



## POSTER HOLDER "PREMIUM" RANGE

Our sign holder range is the ideal way to display important information in office settings, receptions and restaurants. These items are a perfect addition to your shop front, showcase, hostess desk or dining room to grab guests' attention and direct them to your products and services. Flyers and any other printed information are easily inserted into the holder for a professional look in the lobby, shop or reception area of your office. Our range of sizes allows you to place different paper formats straight from your printer into the display easel without the hassle of laminating. The self-standing design rests on a sturdy base so you can arrange any of these models on a flat surface without risk of falling over. "Ready to use" no assembly required.

### L-Shaped Visual Holder

- Manufactured in PMMA with diamond polished edges
- Transparent for optimum visibility of the inserted message
- Food contact certified
- Slanted for a better poster visibility when used below eye level
- Available in smaller formats under "Label Holder" Category

Item Code	Description (Paper Format & Orientation)	Thickness (mm)	Units / Box
SV10040	A7 Landscape L-Shaped Poster Holder	1,5	250
SV10390	A6 Portrait L-Shaped Poster Holder	1,5	20
SV11878	A6 Landscape L-Shaped Poster Holder	1,5	20
SV10085	1/3 A4 Portrait L-Shaped Poster Holder	1,5	50
SV10391	A5 Portrait L-Shaped Poster Holder	1,5	30
SV11877	A5 Landscape L-Shaped Poster Holder	1,5	50
SV10392-S	A4 Portrait L-Shaped Poster Holder	1,5	30
SV11876-S	A4 Landscape L-Shaped Poster Holder	1,5	30
SV10392	A4 Portrait L-Shaped Poster Holder	1,8	30
SV11876	A4 Landscape L-Shaped Poster Holder	1,8	30
SV10033	A3 Portrait L-Shaped Poster Holder	3	20
SV12177	A3 Landscape L-Shaped Poster Holder	3	20



### T-Shaped Visual Holder

- Manufactured in PMMA with diamond polished edges
- Transparent for optimum visibility of the inserted message
- Food contact certified
- Double sided for maximum impact and space optimization on all angles

Item Code	Description (Paper Format & Orientation)	Thickness (mm)	Units / Box
SV10800	A6 Portrait T-Shaped Poster Holder	1,5	50
SV11881	A6 Landscape T-Shaped Poster Holder	1,5	50
SV10801	1/3 A4 Portrait T-Shaped Poster Holder	1,5	50
SV10797	A5 Portrait T-Shaped Poster Holder	1,5	30
SV11880	A5 Landscape T-Shaped Poster Holder	1,5	30
SV10799-S	A4 Portrait T-Shaped Poster Holder	1,5	30
SV11879-S	A4 Landscape T-Shaped Poster Holder	1,5	30
SV10799	A4 Portrait T-Shaped Poster Holder	1,8	30
SV11879	A4 Landscape T-Shaped Poster Holder	2	30
SV10802	A3 Portrait T-Shaped Poster Holder	3	10
SV11862	A3 Landscape T-Shaped Poster Holder	3	10



## POSTER HOLDER "GLASS-LOOK" RANGE

Our sign holder range is the ideal way to display important information in office settings, receptions and restaurants. These items are a perfect addition to your shop front, showcase, hostess desk or dining room to grab guests' attention and direct them to your products and services. Flyers and any other printed information are easily inserted into the holder for a professional look in the lobby, shop or reception area of your office. Our range of sizes allows you to place different paper formats straight from your printer into the display easel without the hassle of laminating. The self-standing design rests on a sturdy base so you can arrange any of these models on a flat surface without risk of falling over. "Ready to use" no assembly required.

### L-Shaped Visual Holder

- Manufactured in PMMA GLASS-LOOK with diamond polished edges
- Transparent for optimum visibility of the inserted message
- Glass-Look finish for premium look
- Food contact certified
- Slanted for a better poster visibility when used below eye level
- Available in smaller formats under "Label Holder" Category

Item Code	Description (Paper Format & Orientation)	Thickness (mm)	Units / Box
SV10040GL	A7 Landscape L-Shaped Poster Holder	1,5	250
SV10390GL	A6 Portrait L-Shaped Poster Holder	1,5	20
SV11878GL	A6 Landscape L-Shaped Poster Holder	1,5	20
SV10391GL	A5 Portrait L-Shaped Poster Holder	1,5	30
SV11877GL	A5 Landscape L-Shaped Poster Holder	1,5	30
SV10392GL	A4 Portrait L-Shaped Poster Holder	1,8	30
SV11876GL	A4 Landscape L-Shaped Poster Holder	1,8	30
SV10033GL	A3 Portrait L-Shaped Poster Holder	3	20
SV12177GL	A3 Landscape L-Shaped Poster Holder	3	20



### T-Shaped Visual Holder

- Manufactured in PMMA GLASS LOOK
- Transparent for optimum visibility of the inserted message with premium look
- Glass-Look finish for premium look
- Food contact certified
- Double sided for maximum impact and space optimization on all angles

Item Code	Description (Paper Format & Orientation)	Thickness (mm)	Units / Box
SV10800GL	A6 Portrait T-Shaped Poster Holder	1,5	50
SV11881GL	A6 Landscape T-Shaped Poster Holder	1,5	50
SV10801GL	1/3 A4 Portrait T-Shaped Poster Holder	1,5	50
SV10797GL	A5 Portrait T-Shaped Poster Holder	1,5	30
SV11880GL	A5 Landscape T-Shaped Poster Holder	1,5	30
SV10799GL	A4 Portrait T-Shaped Poster Holder	2	30
SV11879GL	A4 Landscape T-Shaped Poster Holder	2	30
SV10802GL	A3 Portrait T-Shaped Poster Holder	3	10
SV11862GL	A3 Landscape T-Shaped Poster Holder	3	10



## POSTER HOLDER "UPRIGHT" RANGE

Our sign holder range is the ideal way to display important information in office settings, receptions and restaurants. These items are a perfect addition to your shop front, showcase, hostess desk or dining room to grab guests' attention and direct them to your products and services. Flyers and any other printed information are easily inserted into the holder for a professional look in the lobby, shop or reception area of your office. Our range of sizes allows you to place different paper formats straight from your printer into the display easel without the hassle of laminating. The self-standing design rests on a sturdy base so you can arrange any of these models on a flat surface without risk of falling over. "Ready to use" no assembly required.

### T-Base Visual Holder – Classic

- Transparent for optimum visibility of the inserted message
- Double sided for maximum impact and space optimization on all angles
- Poster insertion from each side and bottom for easy replacement

#### Classic Range

Manufactured in PS with diamond polished edges

Item Code	Description (Paper Format & Orientation)	Thickness (mm)	Units / Box
SP10797STY-S	A7H Upright Poster Holder	1,5	50
SP10798STY-S	A7V Upright Poster Holder	1,5	50
SP10796STY-S	A6H Upright Poster Holder	1,5	50
SP10772STY-S	A6V Upright Poster Holder	1,5	50
SP10794STY-S	1/3A4H Upright Poster Holder	1,5	50
SP10768STY-S	1/3 A4V Upright Poster Holder	1,5	50
SP10770STY	A5H Upright Poster Holder	2	25
SP10771STY	A5V Upright Poster Holder	2	25
SP10730STY	A4H Upright Poster Holder	2	25
SP10731STY	A4V Upright Poster Holder	2	25
SP10795STY	A3H Upright Poster Holder	3	25
SP10769STY	A3V Upright Poster Holder	3	25

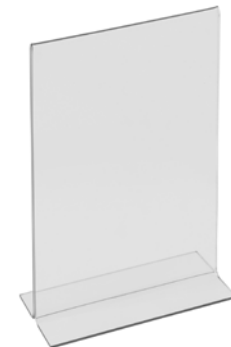

GPPS

#### Premium Range

Manufactured in PMMA and full food contact approved

Item Code	Description (Paper Format & Orientation)	Thickness (mm)	Units / Box
SP10797	A7H Upright Poster Holder	1,5	50
SP10798	A7V Upright Poster Holder	1,5	50
SP10796	A6H Upright Poster Holder	1,5	50
SP10772	A6V Upright Poster Holder	1,5	50
SP10794	1/3A4H Upright Poster Holder	1,5	50
SP10768	1/3 A4V Upright Poster Holder	1,5	50
SP10770	A5H Upright Poster Holder	2	25
SP10771	A5V Upright Poster Holder	2	25
SP10730	A4H Upright Poster Holder	2	25
SP10731	A4V Upright Poster Holder	2	25
SP10795	A3H Upright Poster Holder	3	25
SP10769	A3V Upright Poster Holder	3	25



PMMA

## LABEL HOLDERS

The objective is to offer information in the simplest, least distracting manner possible, and our range does this by displaying information about the products in an easy to read and discreet manner. The label holder makes it easy to display menu items and food types alongside your buffet line or in your bulk goods section for easy identification and our menu bases allow for an easy display of your laminated messages. "Ready to use" no assembly required.

### L-Shaped Label Holder

- Transparent for optimum visibility of the inserted message
- Slanted for a better poster visibility when used below eye level
- Poster insertion is possible from each side for easy replacement

#### Classic Range

Manufactured in PS

Item Code	Description (Paper Format & Orientation)	Thickness (mm)	Units / Box
SV12290STY	Label Holder A9 H	1,5	120
SV12178STY	Label Holder A8 V	1,5	120
SV10040STY	Label Holder A7 H	1,5	250
SV10036STY	Label Holder 50 x 40 mm	1,5	500
SV10037STY	Label Holder 75 x 50 mm	1,5	200
SV10038STY	Label Holder 80 x 55 mm	1,5	200
SV10039STY	Label Holder 100 x 65 mm	1,5	200

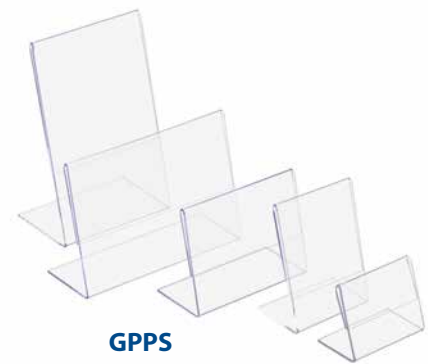

#### Anti-Shock Range

Manufactured in PET, full food contact approved, shock resistant and with increased fire resistance

Item Code	Description (Paper Format & Orientation)	Thickness (mm)	Units / Box
SV12290PET	Label Holder A9 H	0,8	120
SV12178PET	Label Holder A8 V	0,8	120
SV10040PET	Label Holder A7 H	0,8	250
SV12029PET	Label Holder 60 x 20 mm	0,8	500
SV10036PET	Label Holder 50 x 40 mm	1	500
SV12030PET	Label Holder 80 x 25 mm	1	250
SV10037PET	Label Holder 75 x 50 mm	1	200
SV10038PET	Label Holder 80 x 55 mm	1	200
SV10039PET	Label Holder 100 x 65 mm	1	200

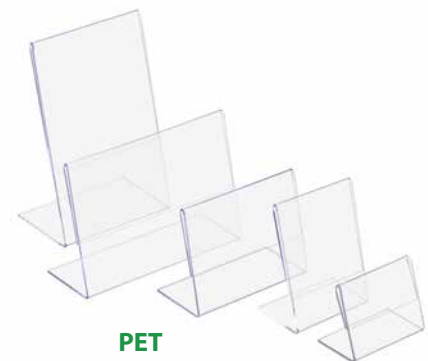

#### Premium Range

Manufactured in PMMA and full food contact approved

Item Code	Description (Paper Format & Orientation)	Thickness (mm)	Units / Box
SV12290	Label Holder A9 H	1,5	120
SV12178	Label Holder A8 H	1,5	120
SV10040	Label Holder A7 H	1,5	250
SV10036	Label Holder 50 x 40 mm	1,5	500
SV10037	Label Holder 75 x 50 mm	1,5	200
SV10038	Label Holder 80 x 55 mm	1,5	200
SV10039	Label Holder 100 x 65 mm	1,5	200

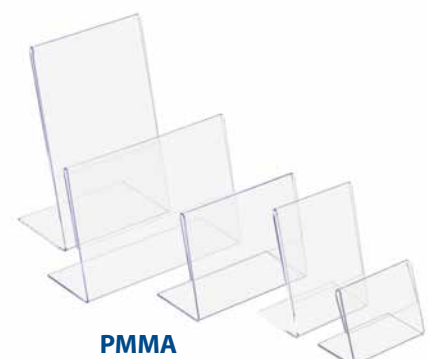



## MAGNETIC FRAMES

Present important information in an attractive way with a simple, colorless construction which makes these products the perfect addition to any environment. The clear holder provides a clean and readable display of your messages. This space-saving design shares twice the amount of information while taking up half the space on your table or counter. Our range of sizes allows you to place different paper formats straight from your printer into the display easel without the hassle of laminating. "Ready to use" no assembly required.

### Magnetic Sign Holders

- Manufactured in PMMA with diamond polished edges
- Transparent for optimum visibility of the inserted message
- Versatile portrait or landscape addition to your visual display, can also be laid flat

#### Classic Range

Item Code	Description (Paper Insert Format)	Thickness (mm)	Units / Box
SV12111	A8 Magnetic Sign Holder 20 mm	2 x 10	50
SV12110	A7 Magnetic Sign Holder 20 mm	2 x 10	25
SV12011	A6 Magnetic Sign Holder 20 mm	2 x 10	20
SV12109	A5 Magnetic Sign Holder 20 mm	2 x 10	10
SV12108	A4 Magnetic Sign Holder 20 mm	2 x 10	10

#### Optimum Range

Item Code	Description (Paper Insert Format)	Thickness (mm)	Units / Box
SV12132	A8 Magnetic Sign Holder 12 mm	2 x 6	50
SV12133	A7 Magnetic Sign Holder 12 mm	2 x 6	50
SV12286	A6 Magnetic Sign Holder 16 mm	2 x 8	20
SV12291	A5 Magnetic Sign Holder 16 mm	2 x 8	20
SV12009	A5 Magnetic Sign Holder 24 mm	2 x 12	5
SV12173	A4 Magnetic Sign Holder 24 mm	2 x 12	5



#### Premium Range

Item Code	Description (Paper Insert Format)	Thickness (mm)	Units / Box
SV12292	A6 Magnetic Sign Holder 30 mm	2 x 15	10
SV12047	A5 Magnetic Sign Holder 30 mm	2 x 15	10
SV12007	A4 Magnetic Sign Holder 30 mm	2 x 15	10

#### Photo Size Range

Item Code	Description (Paper Insert Format)	Thickness (mm)	Units / Box
PH90261	Magnetic Photo Frames 10 x 15	2 x 10	10
PH90262	Magnetic Photo Frames 13 x 18	2 x 10	10
PH90263	Magnetic Photo Frames 15 x 21	2 x 10	10
PH90264	Magnetic Photo Frames 18 x 24	2 x 10	10
PH90308	Magnetic Photo Frames 20 x 25	2 x 10	10
PH90265	Magnetic Photo Frames 20 x 30	2 x 10	10



## MAGNETIC FRAMES

Present important information in an attractive way with a simple, colorless construction which makes these products the perfect addition to any environment. The clear holder provides a clean and readable display of your messages. This space-saving design shares twice the amount of information while taking up half the space on your table or counter. Our range of sizes allows you to place different paper formats straight from your printer into the display easel without the hassle of laminating. "Ready to use" no assembly required.

### T-Shaped Magnetic Sign Holders

- Manufactured in PMMA with diamond polished edges
- Transparent and double sided for optimum visibility of the inserted message or image

#### Classic Range

Item Code	Description (Paper Insert Format)	Thickness (mm)	Units / Box
SV12088	A6 Portrait T-Shaped Magnetic Sign Holder	10	10
SV12112	A6 Landscape T-Shaped Magnetic Sign Holder	10	10
SV12086	A5 Portrait T-Shaped Magnetic Sign Holder	10	5
SV12113	A5 Landscape T-Shaped Magnetic Sign Holder	10	5
SV12084	A4 Portrait T-Shaped Magnetic Sign Holder	10	5
SV12114	A4 Landscape T-Shaped Magnetic Sign Holder	10	5



#### Optimum Range

Item Code	Description (Paper Insert Format)	Thickness (mm)	Units / Box
SP11050	A6 Portrait Magnet Holder - 50 mm Base	2 x 8	5
SP11049	A5 Portrait Magnet Holder - 50 mm Base	2 x 8	5
SP11048	A4 Portrait Magnet Holder - 50 mm Base	2 x 8	5

#### Premium Range

Item Code	Description (Paper Insert Format)	Thickness (mm)	Units / Box
SV12089	A6 Portrait T-Shaped Magnetic Sign Holder	10 & 20	10
SV12115	A6 Landscape T-Shaped Magnetic Sign Holder	10 & 20	10
SV12087	A5 Portrait T-Shaped Magnetic Sign Holder	10 & 20	5
SV12116	A5 Landscape T-Shaped Magnetic Sign Holder	10 & 20	5
SV12085	A4 Portrait T-Shaped Magnetic Sign Holder	10 & 20	5
SV12117	A4 Landscape T-Shaped Magnetic Sign Holder	10 & 20	5



## MAGNETIC FRAMES

Present important information in an attractive way with a simple, colorless construction which makes these items the perfect addition to any environment. Our range of sizes allows you to place different paper formats straight from your printer into the display easel. "Ready to use" no assembly required.

### L-Shaped Magnetic Sign Holders

- Manufactured in PMMA with diamond polished edges
- Transparent and slanted for optimum visibility of the inserted message or image
- Designed at the perfect viewing angle for passing customers and usage below eye level

Item Code	Description (Paper Format & Orientation)	Thickness (mm)	Units / Box
SV12106	A8 Portrait L-Shaped Magnetic Holder	2 x 5	50
SV12171	A7 Portrait L-Shaped Magnetic Holder	2 x 5	10
SV12174	A6 Portrait L-Shaped Magnetic Holder	2 x 6	50
SV12103	A6 Portrait L-Shaped Magnetic Holder	2 x 8	10
SV12121	A6 Landscape L-Shaped Magnetic Holder	2 x 8	10
SV12107	A5 Portrait L-Shaped Magnetic Holder	2 x 8	10
SV12122	A5 Landscape L-Shaped Magnetic Holder	2 x 8	10
SV12104	A4 Portrait L-Shaped Magnetic Holder	2 x 8	5
SV12123	A4 Landscape L-Shaped Magnetic Holder	2 x 8	5



### Magnetic Sign Holders with Triangle Foot

- Manufactured in PMMA with diamond polished edges
- Transparent and slanted for optimum visibility of the inserted message or image
- Stability foot can be removed or repositioned for portrait and landscape usage

Item Code	Description (Paper Insert Format)	Thickness (mm)	Units / Box
SV12098	A6 Portrait Delta Magnetic Sign Holder	2 x 8	10
SV12097	A5 Portrait Delta Magnetic Sign Holder	2 x 8	10
SV12096	A4 Portrait Delta Magnetic Sign Holder	2 x 8	10



### Colored Back Photo Blocks

- Manufactured in PMMA with diamond polished edges
- Transparent and slanted for optimum visibility of the inserted message or image
- Stability foot can be removed or repositioned for portrait and landscape usage

Item Code	Description (Paper Insert Format)	Thickness (mm)	Units / Box
SV11968NR	Black Back Photo Block 10 x 15	10	20
SV11969NR	Black Back Photo Block 13 x 18	10	10
SV11968B	White Back Photo Block 10 x 15	10	20
SV11969B	White Back Photo Block 13 x 18	10	10
SV11968FLR	Fluorescent Red Back Photo Block 10 x 15	10	20
SV11969FLR	Fluorescent Red Back Photo Block 13 x 18	10	10
SV11968FLV	Fluorescent Yellow Back Photo Block 10 x 15	10 & 8	20
SV11969FLV	Fluorescent Yellow Back Photo Block 13 x 18	10 & 8	10



## COLORED BASE MENU STAND

Our range of menu / poster holders with colored base is the perfect way to showcase your messages with ease. The line is conceived to show off messages in an attractive way. The durable clear acrylic easily holds menus, wine lists, or drink menus so you can see your insert from either side. The design makes it ideal for areas where space is limited. Our range of sizes allows you to place different paper formats straight from your printer into the display easel.

### Menu Stand Poster Holder Color Base

- Manufactured in PMMA with diamond polished edges
- Versatile single or dual sided addition to your visual display

#### Green 8 mm Base

Item Code	Description (Paper Format & Orientation)	Thickness (mm)	Units / Box
SV12304FLV	A6 Portrait Poster Holder with Fluo Green Base	1.5 & 8	20
SV12305FLV	A6 Landscape Poster Holder with Fluo Green Base	1.5 & 8	20
SV12306FLV	A5 Portrait Poster Holder with Fluo Green Base	1.5 & 8	10
SV12307FLV	A5 Landscape Poster Holder with Fluo Green Base	1.5 & 8	10
SV12308FLV	A4 Portrait Poster Holder with Fluo Green Base	1.5 & 8	10
SV12309FLV	A4 Landscape Poster Holder with Fluo Green Base	1.5 & 8	10
SV12310FLV	A3 Portrait Poster Holder with Fluo Green Base	1.5 & 8	3
SV12311FLV	A3 Landscape Poster Holder with Fluo Green Base	1.5 & 8	3

#### Red 8 mm Base

Item Code	Description (Paper Format & Orientation)	Thickness (mm)	Units / Box
SV12304FLR	A6 Portrait Poster Holder with Fluo Red Base	1.5 & 8	20
SV12305FLR	A6 Landscape Poster Holder with Fluo Red Base	1.5 & 8	20
SV12306FLR	A5 Portrait Poster Holder with Fluo Red Base	1.5 & 8	10
SV12307FLR	A5 Landscape Poster Holder with Fluo Red Base	1.5 & 8	10
SV12308FLR	A4 Portrait Poster Holder with Fluo Red Base	1.5 & 8	10
SV12309FLR	A4 Landscape Poster Holder with Fluo Red Base	1.5 & 8	10
SV12310FLR	A3 Portrait Poster Holder with Fluo Red Base	1.5 & 8	3
SV12311FLR	A3 Landscape Poster Holder with Fluo Red Base	1.5 & 8	3

#### Green 20 mm Base

Item Code	Description (Paper Format & Orientation)	Thickness (mm)	Units / Box
SV12304FLV	A6 Portrait Poster Holder with Fluo Green Base	1.5 & 20	20
SV12305FLV	A6 Landscape Poster Holder with Fluo Green Base	1.5 & 20	20
SV12306FLV	A5 Portrait Poster Holder with Fluo Green Base	1.5 & 20	10
SV12307FLV	A5 Landscape Poster Holder with Fluo Green Base	1.5 & 20	10
SV12308FLV	A4 Portrait Poster Holder with Fluo Green Base	1.5 & 20	10
SV12309FLV	A4 Landscape Poster Holder with Fluo Green Base	1.5 & 20	10
SV12310FLV	A3 Portrait Poster Holder with Fluo Green Base	1.5 & 20	3
SV12311FLV	A3 Landscape Poster Holder with Fluo Green Base	1.5 & 20	3

#### Red 20 mm Base

Item Code	Description (Paper Format & Orientation)	Thickness (mm)	Units / Box
SV12304FLR	A6 Portrait Poster Holder with Fluo Red Base	1.5 & 20	20
SV12305FLR	A6 Landscape Poster Holder with Fluo Red Base	1.5 & 20	20
SV12306FLR	A5 Portrait Poster Holder with Fluo Red Base	1.5 & 20	10
SV12307FLR	A5 Landscape Poster Holder with Fluo Red Base	1.5 & 20	10
SV12308FLR	A4 Portrait Poster Holder with Fluo Red Base	1.5 & 20	10
SV12309FLR	A4 Landscape Poster Holder with Fluo Red Base	1.5 & 20	10
SV12310FLR	A3 Portrait Poster Holder with Fluo Red Base	1.5 & 20	3
SV12311FLR	A3 Landscape Poster Holder with Fluo Red Base	1.5 & 20	3

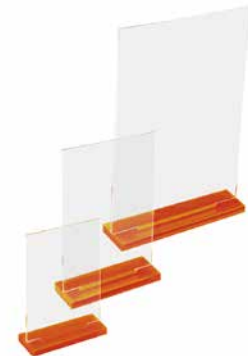



## WOOD MIX VISUAL HOLDERS

Our range of poster / menu holders with wooden base is the perfect way to showcase your messages with ease. The line is conceived to show off your directions, menus or any other important messages in an attractive way. The durable clear acrylic part easily holds messages so you can see your insert from either side. This range features an attractive and an easy-to-clean real wood base. The design makes it ideal for areas where space is limited. It's great for contemporary restaurants and bars as it easily displays menus and specials at your tabletops or bars without taking up a lot of space. Our range of sizes allows you to place different paper formats straight from your printer into the display easel.

### Menu Stand Poster Holder Wooden Base - Premium Range

- Manufactured in PMMA and real wood.
- Diamond polished edges
- Versatile portrait single or dual sided addition to your visual display
- Quick and easy to install and replace posters on your counter or shelf

### Light Wood (Pine) Base

Item Code	Description (Paper Format & Orientation)	Thickness (mm)	Units / Box
SV12360BOIS-C	A7 Portrait Poster Holder - Light Wood (Pine) Base	1.5 & 28 mm	25
SV12362BOIS-C	A7 Landscape Poster Holder - Light Wood (Pine) Base	1.5 & 28 mm	25
SV12304BOIS-C	A6 Portrait Poster Holder - Light Wood (Pine) Base	1.5 & 28 mm	20
SV12305BOIS-C	A6 Landscape Poster Holder - Light Wood (Pine) Base	1.5 & 28 mm	20
SV12306BOIS-C	A5 Portrait Poster Holder - Light Wood (Pine) Base	1.5 & 28 mm	10
SV12307BOIS-C	A5 Landscape Poster Holder - Light Wood (Pine) Base	1.5 & 28 mm	10
SV12308BOIS-C	A4 Portrait Poster Holder - Light Wood (Pine) Base	1.5 & 28 mm	10
SV12309BOIS-C	A4 Landscape Poster Holder - Light Wood (Pine) Base	1.5 & 28 mm	10



### Dark Wood (Oak) Base

Item Code	Description (Paper Format & Orientation)	Thickness (mm)	Units / Box
SV12360BOIS-F	A7 Portrait Poster Holder - Dark Wood (Oak) Base	1.5 & 28 mm	25
SV12362BOIS-F	A7 Landscape Poster Holder - Dark Wood (Oak) Base	1.5 & 28 mm	25
SV12304BOIS-F	A6 Portrait Poster Holder - Dark Wood (Oak) Base	1.5 & 28 mm	20
SV12305BOIS-F	A6 Landscape Poster Holder - Dark Wood (Oak) Base	1.5 & 28 mm	20
SV12306BOIS-F	A5 Portrait Poster Holder - Dark Wood (Oak) Base	1.5 & 28 mm	10
SV12307BOIS-F	A5 Landscape Poster Holder - Dark Wood (Oak) Base	1.5 & 28 mm	10
SV12308BOIS-F	A4 Portrait Poster Holder - Dark Wood (Oak) Base	1.5 & 28 mm	10
SV12309BOIS-F	A4 Landscape Poster Holder - Dark Wood (Oak) Base	1.5 & 28 mm	10



## WOOD MIX VISUAL HOLDERS

Our range is manufactured in acrylic and wood and is the perfect way to showcase your messages with ease. The items feature attractive and an easy-to-clean real wood base with designs that make them ideal for areas where space is limited. Our range of sizes allows you to place different paper formats straight from your printer into the display easel. "Ready to use" no assembly required.

### Magnetic Sign Blocks

- Manufactured in PMMA with diamond polished edges and real wood
- Transparent front for optimum visibility of the inserted message or image and wooden back
- Versatile portrait or landscape addition to your visual display, can also be laid flat

Item Code	Description (Paper Insert Format)	Thickness (mm)	Units / Box
SV11968BOIS-C	Light Wood (Pine) Back Photo Blocks 10 x 15	10 & 14	10
SV11969BOIS-C	Light Wood (Pine) Back Photo Blocks 13 x 18	10 & 14	10
SV12009BOIS-C	Light Wood (Pine) Back Photo Blocks 15 x 21	10 & 14	5
SV11968BOIS-F	Dark Wood (Oak) Back Photo Blocks 10 x 15	10 & 14	10
SV11969BOIS-F	Dark Wood (Oak) Back Photo Blocks 13 x 18	10 & 14	10
SV12009BOIS-F	Dark Wood (Oak) Back Photo Blocks 15 x 21	10 & 14	5



### T-Shaped Magnetic Sign Holders

- Manufactured in PMMA with diamond polished edges and real wood
- Transparent front and/or back for optimum visibility of the inserted message or image
- Versatile portrait single or dual sided addition to your visual display

#### Single Sided

Item Code	Description (Paper Insert Format)	Thickness (mm)	Units / Box
SV12295BOIS-C	Light Wood (Pine) Back Photo Holder 10 x 15	6 & 12	5
SV12296BOIS-C	Light Wood (Pine) Back Photo Holder 13 x 18	6 & 12	5
SV12297BOIS-C	Light Wood (Pine) Back Photo Holder 15 x 21	6 & 12	5
SV12295BOIS-F	Dark Wood (Oak) Back Photo Holder 10 x 15	6 & 12	5
SV12296BOIS-F	Dark Wood (Oak) Back Photo Holder 13 x 18	6 & 12	5
SV12297BOIS-F	Dark Wood (Oak) Back Photo Holder 15 x 21	6 & 12	5

#### Double Sided

Item Code	Description (Paper Insert Format)	Thickness (mm)	Units / Box
SV12298BOIS-C	Light Wood (Pine) Dual Sided Photo Holder 10 x 15	6 & 12	5
SV12299BOIS-C	Light Wood (Pine) Dual Sided Photo Holder 13 x 18	6 & 12	5
SV12300BOIS-C	Light Wood (Pine) Dual Sided Photo Holder 15 x 21	6 & 12	5
SV12298BOIS-F	Dark Wood (Oak) Dual Sided Photo Holder 10 x 15	6 & 12	5
SV12299BOIS-F	Dark Wood (Oak) Dual Sided Photo Holder 13 x 18	6 & 12	5
SV12300BOIS-F	Dark Wood (Oak) Dual Sided Photo Holder 15 x 21	6 & 12	5



### Rotating Sign Holder

- Manufactured in PMMA with diamond polished edges and real wood
- Transparent front and/or back for optimum visibility of the inserted message or image
- Available in different acrylic colors upon request

Item Code	Description (Paper Insert Format)	Thickness (mm)	Units / Box
SV12413BOIS	A5 Portrait Poster Holder – Dark Wood (Oak) Base	2	5
SV12412BOIS	A4 Portrait Poster Holder – Dark Wood (Oak) Base	2	5







## WOOD MIX HOLDERS

Our range is manufactured in acrylic and wood and is the perfect way to showcase your messages with ease. The items feature attractive and an easy-to-clean real wood base with designs that make them ideal for areas where space is limited. Our range of sizes allows you to place different paper formats straight from your printer into the display easel. "Ready to use" no assembly required.

### Leaflet Dispenser

- Manufactured in PMMA and real wood.
- Diamond polished edges
- Quick and easy to install and feed posters on your counter or shelf

Item Code	Description	Thickness (mm)	Units / Box
SV12397BOIS-F	A6 Portrait Leaflet Holder (Oak)	3	5
SV12396BOIS-F	1/3 A4 DL Portrait Leaflet Holder (Oak)	3	5
SV12395BOIS-F	A5 Portrait Leaflet Holder (Oak)	3	5



### LED Message Holder

- Manufactured in PMMA
- Diamond polished edges
- Battery powered with On/Off button on bottom
- Integrated LED in the base help emit a white light to emphasize your message

Item Code	Description	Thickness (mm)	Units / Box
SV12398BOIS-F-LED	A5 Portrait Visual Display with Wood Base (Oak)	3	5
SV12399BOIS-F-LED	A4 Portrait Visual Display with Wood Base (Oak)	3	5



### Multi-Usage Storage Tube/Round Box

- Manufactured in Clear PMMA
- Versatile clean and sleek design allowing customers to easily view the items on display
- Diamond polished edges

Item Code	Description	Thickness (mm)	Units / Box
AG21160BOIS	Round Box Ø 10 x H 10 cm	3	4
AG21161BOIS	Round Box Ø 15 x H 10 cm	3	4
AG21157BOIS	Round Box Ø 15 x H 15 cm	3	4
AG21156BOIS	Round Box Ø 20 x H 15 cm	3	4
AG21191BOIS	Round Box Ø 20 x H 20 cm	3	4



### Multi-Usage Storage Box

- Manufactured in Clear PMMA
- Versatile clean and sleek design allowing customers to easily view the items on display
- Diamond polished edges

Item Code	Description	Thickness (mm)	Units / Box
AG21149BOIS	Box L 12 x D 12 x H 10 cm	3	4
AG21150BOIS	Box L 15 x D 15 x H 10 cm	3	4
AG20960BOIS	Box L 20 x D 20 x H 10 cm	3	4
AG21152BOIS	Box L 20 x D 20 x H 20 cm	3	4





## ALUMINIUM BASE VISUAL HOLDERS

Our range of poster / menu holders with aluminium base is the perfect way to showcase your messages with ease. The line is conceived to show off your directions, menus or any other important messages in an attractive way. The durable clear acrylic part easily holds messages so you can see your insert from either side. This range features an attractive and an easy-to-clean aluminium base. The design makes it ideal for areas where space is limited. Our range of sizes allows you to place different paper formats straight from your printer into the display easel.

### Poster Holder

- Manufactured in PMMA and aluminium
- Diamond polished edges
- Versatile portrait single or dual sided addition to your visual display
- With clamping system for secure hold and easy replacement of the acrylic panel
- Quick and easy to install and replace posters on your counter or shelf



Item Code	Description (Paper Format & Orientation)	Thickness (mm)	Units / Box
SV12373-ALU	A6 Portrait Alu Base Visual Holder	1,5	5
SV12374-ALU	A6 Landscape Alu Base Visual Holder	1,5	5
SV12375-ALU	A5 Portrait Alu Base Visual Holder	1,5	5
SV12376-ALU	A5 Landscape Alu Base Visual Holder	1,5	5
SV12377-ALU	A4 Portrait Alu Base Visual Holder	1,5	5
SV12378-ALU	A4 Landscape Alu Base Visual Holder	1,5	5

### Name / Label Holder

- Manufactured in PMMA and aluminium
- Diamond polished edges
- Versatile portrait single or dual sided addition to your visual display
- With clamping system for secure hold and easy replacement of the acrylic panel
- Quick and easy to install and replace posters on your counter or shelf

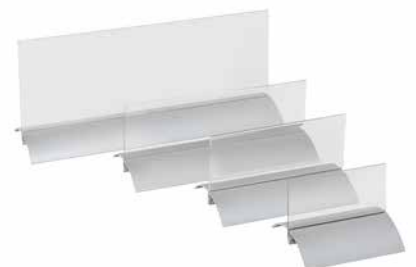

Item Code	Description (Paper Format & Orientation)	Thickness (mm)	Units / Box
SV12379-ALU	L 100 x H 52 mm Alu Base Message Holder	1,5	5
SV12380-ALU	L 150 x H 61 mm Alu Base Message Holder	1,5	5
SV12381-ALU	L 210 x H 61 mm Alu Base Message Holder	1,5	5
SV12382-ALU	L 297 x H 105 mm Alu Base Message Holder	1,5	5





## MENU HOLDERS

The objective is to offer information in the simplest, least distracting manner possible, and the Label Holder does this by displaying information about the products in an easy to read and discreet manner. The label holder makes it easy to display menu items and food types alongside your buffet line or in your bulk goods section for easy identification. "Ready to use" no assembly required.

### A-Shaped Visual Holder

- Manufactured in PS with diamond polished edges
- Transparent and double sided for optimum visibility of the inserted message
- Slanted for a better poster visibility when used below eye level

Item Code	Description (Paper Format & Orientation)	Thickness (mm)	Units / Box
SP10787STY	A7 Portrait A-Shaped Poster Holder	2	50
SP10759STY	A7 Landscape A-Shaped Poster Holder	2	50
SP10786STY	A6 Portrait A-Shaped Poster Holder	2	50
SP10773STY	A6 Landscape A-Shaped Poster Holder	2	50
SP10782STY	1/3 A4 Portrait A-Shaped Poster Holder	2	50
SP10781STY	1/3 A4 Landscape A-Shaped Poster Holder	2	50
SP10735STY	A5 Portrait A-Shaped Poster Holder	2	25
SP10758STY	A5 Landscape A-Shaped Poster Holder	2	25
SP10785STY	A4 Portrait A-Shaped Poster Holder	2	25
SP10734STY	A4 Landscape A-Shaped Poster Holder	2	25
SP10784STY	A3 Portrait A-Shaped Poster Holder	2	10
SP10783STY	A3 Landscape A-Shaped Poster Holder	2	10

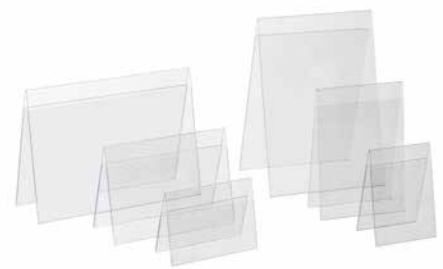

### Menu Holder with Removable Base

- Manufactured in PMMA with anti-slip feet and diamond polished edges
- Transparent and double sided for optimum visibility of the inserted message
- Full food contact certified
- Double sided for maximum impact and space optimization on all angles

Item Code	Description (Paper Insert Format)	Thickness (mm)	Units / Box
SV10169	A6 Portrait Menu Holder with Removable Base	3 mm	30
SV10170	1/3 A4 Portrait Menu Holder with Removable Base	3 mm	30
SV10171	A5 Portrait Menu Holder with Removable Base	3 mm	20
SV10172	A4 Portrait Menu Holder with Removable Base	3 mm	20
SV10173	A3 Portrait Menu Holder with Removable Base	3 mm	10



## MENU HOLDERS

The objective is to offer information in the simplest, least distracting manner possible, and the Label Holder does this by displaying information about the products in an easy to read and discreet manner. The label holder makes it easy to display menu items and food types alongside your buffet line or in your bulk goods section for easy identification. "Ready to use" no assembly required.

### A-Shaped Label Holder

- Transparent and double sided for optimum visibility of the inserted message
- Slanted for a better poster visibility when used below eye level

#### Classic Range

Manufactured in PS with diamond polished edges

Item Code	Description (Length x Height mm)	Thickness (mm)	Units / Box
SV10041STY	2 - Sided Label Holder L 100 x H 40	1,5	250
SV10042STY	2 - Sided Label Holder L 150 x H 40	1,5	150
SV10043STY	2 - Sided Label Holder L 200 x H 40	1,5	100
SV10066STY	2 - Sided Label Holder L 300 x H 105	1,5	25



GPPS

#### Anti-Shock Range

Manufactured in PET, full food contact approved, shock resistant and with increased fire resistance

Item Code	Description (Length x Height mm)	Thickness (mm)	Units / Box
SV12372PET	2 - Sided Label Holder L 95 x H 42	1	100
SV10041PET	2 - Sided Label Holder L 100 x H 40	1	250
SV12364PET	2 - Sided Label Holder L 100 x H 60	1	100
SV10042PET	2 - Sided Label Holder L 150 x H 40	1	150
SV12363PET	2 - Sided Label Holder L 190 x H 60	1	50
SV10043PET	2 - Sided Label Holder L 200 x H 40	1	100
SV10066PET	2 - Sided Label Holder L 300 x H 105	1	25



PET

#### Premium Range

Manufactured in PMMA with diamond polished edges

Item Code	Description (Length x Height mm)	Thickness (mm)	Units / Box
SV10041	2 - Sided Label Holder L 100 x H 40	1,5	100
SV12320	2 - Sided Label Holder L 150 x H 61	1,5	100
SV12321	2 - Sided Label Holder L 200 x H 61	1,5	100
SV12322	2 - Sided Label Holder L 297 x H 105	1,5	50
SV12332	2 - Sided Name Holder L 105 x 40 mm (A7 folded)	1,5	100
SV12331	2 - Sided Name Holder L 150 x 55 mm (A6 folded)	1,5	100
SV12330	2 - Sided Name Holder L 210 x 75mm (A5 folded)	1,5	50
SV12329	2 - Sided Name Holder L 300 x 105 mm (A4 folded)	1,5	50

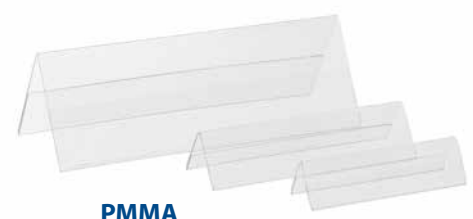

PMMA



## MENU HOLDERS

Our range of menu holders is the perfect way to convey information to guests before they ask. Our size range allows you to place different paper formats straight from your printer into the display easel without the hassle of laminating. With our table tents, you may showcase multiple different important messages at the same time. These items are a must-have in virtually any business. "Ready to use" no assembly required.

### Star Shaped Menu Holder

- Transparent for optimum visibility of the inserted message
- 6 - Sided acrylic table tent is an easy and attractive way to show off up to 6 different table menus, specials, or any other important messages for your customers.

### Anti-Shock Range

Manufactured in PET, full food contact approved, shock resistant and with increased fire resistance

Item Code	Description (Paper Insert Format)	Thickness (mm)	Units / Box
SV12040PET	A6 Portrait Y-Shaped Menu Holder	1	36
SV10047PET	1/3 A4 Portrait Y-Shaped Menu Holder	1	20
SV10048PET	A5 Portrait Y-Shaped Menu Holder	1	30
SV10049PET	A4 Portrait Y-Shaped Menu Holder	1	20

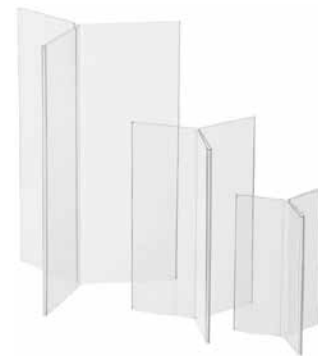

### Classic Range

Manufactured in PS with diamond polished edges

Item Code	Description (Paper Insert Format)	Thickness (mm)	Units / Box
SV12040STY	A6 Portrait Y-Shaped Menu Holder	1,5	36
SV10047STY	1/3 A4 Portrait Y-Shaped Menu Holder	1,5	20
SV10048STY	A5 Portrait Y-Shaped Menu Holder	1,5	30
SV10049STY	A4 Portrait Y-Shaped Menu Holder	1,5	20



### Triangle Shaped Menu Holder Premium Range

- Manufactured in PMMA with diamond polished edges
- Transparent for optimum visibility of the inserted message with premium look
- Full food contact certified
- 3 - Sided acrylic table tent is an easy and attractive way to show off up to 3 different table menus, specials, or any other important messages for your customers.
- Poster insertion is possible from upper side of the product

Item Code	Description (Paper Insert Format)	Thickness (mm)	Units / Box
SV11884	A6 Portrait Triple Menu Holder	2	30
SV10308	1/3 A4 Portrait Triple Menu Holder	2	30
SV11883	A5 Portrait Triple Menu Holder	2	10
SV11882	A4 Portrait Triple Menu Holder	2	10



## MENU HOLDERS

Our range of menu holders is the perfect way to convey information to guests before they ask. Our size range allows you to place different paper formats straight from your printer into the display easel without the hassle of laminating. With our table tents, you may showcase multiple different important messages at the same time. These items are a must-have in virtually any business. "Ready to use" no assembly required.

### Colored Frame L-Shape Poster Holder

- Manufactured in PS with diamond polished edges
- Permanent colored wide border frame to draw attention to insert
- Slanted for better poster visibility when used below eye level
- Poster insertion possible from each side for easy replacement.

#### Black Frame

Item Code	Description (Paper Insert Format)	Thickness (mm)	Units / Box
SP11161STY	A5 Portrait L-Shape Holder	1.5	30
SP11160STY	A4 Portrait L-Shape Holder	1.8	30



#### Red Frame

Item Code	Description (Paper Insert Format)	Thickness (mm)	Units / Box
SP11161STY-R	A5 Portrait L-Shape Holder	1,5	36
SP11160STY-R	A4 Portrait L-Shape Holder	1,8	20

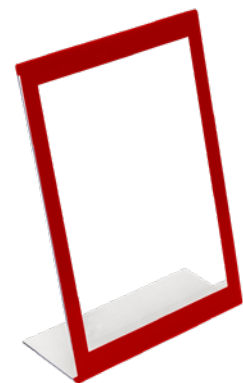

### Foldable Poster Holder

- Manufactured in PET
- 2 Sided
- Full food contact approved
- Shock resistant
- Easy to store (foldable) and even to send in an envelope

Item Code	Description (Paper Insert Format)	Thickness (mm)	Units / Box
SV12400PET	A6 Portrait Foldable	0,9	20
SV12401PET	1/3 A4 Portrait Foldable	0,9	20
SV12365PET	A5 Portrait Foldable	0,9	20
SV12368PET	A4 Portrait Foldable	1	20





## MENU HOLDERS

Our range of menu holders is the perfect way to convey information to guests before they ask. Our size range allows you to place different paper formats straight from your printer into the display easel without the hassle of laminating. With our table tents, you may showcase multiple different important messages at the same time. These items are a must-have in virtually any business. "Ready to use" no assembly required.

### Poster Holder with Removable Base

- Manufactured in Clear PET and Colored PVC Base
- Transparent and double sided for maximum impact and space optimization on all angles
- Available for individual part purchase as well as multiple color options on request



Item Code	Description (Paper Insert Format)	Thickness (mm)	Units / Box
SV12416PET-NOIR	A6 Portrait Poster + Black Base	0,5 + 1 mm	15
SV12416PET-BLANC	A6 Portrait Poster + White Base	0,5 + 1 mm	15
SV12415PET-NOIR	A5 Portrait Poster + White Base	0,5 + 1 mm	10
SV12415PET-BLANC	A5 Portrait Poster + White Base	0,5 + 1 mm	10
SV12414PET-NOIR	A4 Portrait Poster + Black Base	0,5 + 1 mm	10
SV12414PET-BLANC	A4 Portrait Poster + White Base	0,5 + 1 mm	10



### Clip Menu Base

- Manufactured in PS
- Transparent holding base for cards and stiff leaflets of up to 2 mm thickness
- Diamond polished edges
- Allows quick insert replacement

Item Code	Description (Length x Height mm)	Thickness (mm)	Units / Box
SV12044	Clip Menu Base L 50 x H 40	1,5	50
SV12045	Clip Menu Base L 100 x H 40	1,5	50



### Triangle Menu Base

- Manufactured in PS
- Transparent holding base for cards and stiff leaflets of up to 2 mm thickness
- Diamond polished edges
- Allows quick insert replacement

Item Code	Description (Length x Height mm)	Thickness (mm)	Units / Box
SV10180	Triangle Shaped Menu Base L 76	3	60
SV11901	Triangle Shaped Menu Base L 105	3	30
SV11902	Triangle Shaped Menu Base L 148	3	20
SV11903	Triangle Shaped Menu Base L 210	3	20



## INFORMATION FRAMES

Our range of poster frames are the easiest solution to attach documents or messages to metal surfaces. They are manufactured in high quality Anti-Glare PET, making them break/shatterproof, light and more flexible than other solutions produced in acrylic. Present important information in an attractive and easy to use way. Available in a wide variety of sizes and colors. "Ready to use" no assembly required.

### Frames for Metal Surfaces

- Manufactured in Anti-Glare PET
- Insert and replace documents quickly
- Break and shatterproof, increased fire resistance
- Easy to attach to all metal surfaces like whiteboards, display boards, lockers, production machinery etc.
- Can be used for both portrait and landscape formats

### Single Color

Item Code	Description (Paper Insert Format)	Thickness (mm)	Units / Box
SV12385-NOIR	A5 Format	0.3	50
SV12384-NOIR	A4 Format	0.3	30
SV12383-NOIR	A3 Format	0.3	30
SV12385-ROUGE	A5 Format	0.3	50
SV12384-ROUGE	A4 Format	0.3	30
SV12383-ROUGE	A3 Format	0.3	30
SV12385-GRIS	A5 Format	0.3	50
SV12384-GRIS	A4 Format	0.3	30
SV12383-GRIS	A3 Format	0.3	30
SV12385-GRIS	A5 Format	0.3	50
SV12384-GRIS	A4 Format	0.3	30
SV12383-GRIS	A3 Format	0.3	30
SV12385-VERT	A5 Format	0.3	50
SV12384-VERT	A4 Format	0.3	30
SV12383-VERT	A3 Format	0.3	30

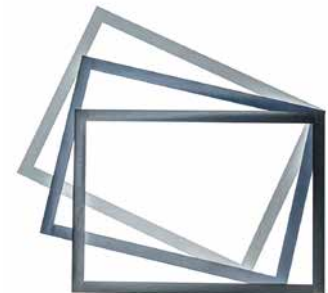

### Dual Color

Item Code	Description (Paper Insert Format)	Thickness (mm)	Units / Box
SV12388-GRIS/JAUNE	A5 Format	0.3	50
SV12387-GRIS/JAUNE	A4 Format	0.3	30
SV12386-GRIS/JAUNE	A3 Format	0.3	30
SV12388-ROUGE/BLANC	A5 Format	0.3	50
SV12387-ROUGE/BLANC	A4 Format	0.3	30
SV12386-ROUGE/BLANC	A3 Format	0.3	30
SV12388-VERT/BLANC	A5 Format	0.3	50
SV12387-VERT/BLANC	A4 Format	0.3	30
SV12386-VERT/BLANC	A3 Format	0.3	30





## INFORMATION FRAMES

Our range of poster frames are the easiest solution to attach documents or messages to metal surfaces. They are manufactured in high quality Anti-Glare PET, making them break/shatterproof, light and more flexible than other solutions produced in acrylic. Present important information in an attractive and easy to use way. Available in a wide variety of sizes and colors. "Ready to use" no assembly required.

### Single Color Frames for Flat Surfaces - Quick Fix

- Manufactured in Anti-Glare PET
- Insert and replace documents quickly, readable from both sides if 2 inlays are used
- Break and shatterproof, increased fire resistance
- Easy to attach to smooth, flat surfaces without the need for tools and can removed again
- Easy to stick to any flat surface with 2 adhesive strips on the back
- Ideal for room plans, orientation information, opening hours etc
- Can be used for both portrait and landscape formats

### Single Color

Item Code	Description (Paper Insert Format)	Thickness (mm)	Units / Box
SV12391-NOIR-S	A5 Format	0.3	50
SV12390-NOIR-S	A4 Format	0.3	30
SV12389-NOIR-S	A3 Format	0.3	30
SV12391-ROUGE-S	A5 Format	0.3	50
SV12390-ROUGE-S	A4 Format	0.3	30
SV12389-ROUGE-S	A3 Format	0.3	30
SV12391-GRIS-S	A5 Format	0.3	50
SV12390-GRIS-S	A4 Format	0.3	30
SV12389-GRIS-S	A3 Format	0.3	30
SV12391-BLUE-S	A5 Format	0.3	50
SV12390-BLUE-S	A4 Format	0.3	30
SV12389-BLUE-S	A3 Format	0.3	30
SV12391-VERT-S	A5 Format	0.3	50
SV12390-VERT-S	A4 Format	0.3	30
SV12389-VERT-S	A3 Format	0.3	30

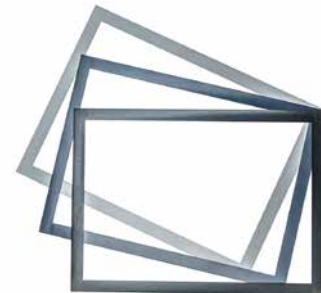

### Dual Color

Item Code	Description (Paper Insert Format)	Thickness (mm)	Units / Box
SV12394-GRIS/JAUNE-S	A5 Format	0.3	50
SV12393-GRIS/JAUNE-S	A4 Format	0.3	30
SV12392-GRIS/JAUNE-S	A3 Format	0.3	30
SV12394-ROUGE/BLANC-S	A5 Format	0.3	50
SV12393-ROUGE/BLANC-S	A4 Format	0.3	30
SV12392-ROUGE/BLANC-S	A3 Format	0.3	30
SV12394-VERT/BLANC-S	A5 Format	0.3	50
SV12393-VERT/BLANC-S	A4 Format	0.3	30
SV12392-VERT/BLANC-S	A3 Format	0.3	30



## POSTER POCKETS / SLEEVES

The slide-in poster pockets are specifically designed for wall mounting posters, information sheets, product specifications and directions. Present important information in an attractive way with a simple, colorless construction which makes these items the perfect addition to any environment. They are cost-effective and come in a wide variety of popular poster sizes both portrait and landscape. The durable acrylic ensures your poster is secure, ideal for displaying promotions, menus or other information.

### Multi-Surface Poster Holder / Sleeve

- Manufactured in PMMA with diamond polished edges
- Transparent for optimum visibility of the inserted message
- Can be mounted using the already placed adhesive strips or screwed on all surfaces

Item Code	Description (Paper Format & Orientation)	Thickness (mm)	Units / Box
SV12247ADH	A6 Portrait Multi-Surface Poster Sleeve	3	20
SV11868ADH	A6 Landscape Multi-Surface Poster Sleeve	3	20
SV12246ADH	A5 Portrait Multi-Surface Poster Sleeve	3	15
SV11867ADH	A5 Landscape Multi-Surface Poster Sleeve	3	15
SV12245ADH	A4 Portrait Multi-Surface Poster Sleeve	3	10
SV11866ADH	A4 Landscape Multi-Surface Poster Sleeve	3	10
SV12244ADH	A3 Portrait Multi-Surface Poster Sleeve	3	5
SV11865ADH	A3 Landscape Multi-Surface Poster Sleeve	3	5



### Perforated Poster Sleeve

- Manufactured in PS with diamond polished edges
- Transparent with perforated top lip for optimum visibility of the inserted message

Item Code	Description (Paper Format & Orientation)	Thickness (mm)	Units / Box
SV10009STY	A6 Portrait Multi-Surface Poster Sleeve	2	30
SV10002STY	A6 Landscape Multi-Surface Poster Sleeve	2	30
SV10010STY	A5 Portrait Multi-Surface Poster Sleeve	2	25
SV10003STY	A5 Landscape Multi-Surface Poster Sleeve	2	25
SV10011STY	A4 Portrait Multi-Surface Poster Sleeve	2	30
SV10004STY	A4 Landscape Multi-Surface Poster Sleeve	2	30
SV10012STY	A3 Portrait Multi-Surface Poster Sleeve	2	15
SV10005STY	A3 Landscape Multi-Surface Poster Sleeve	2	15

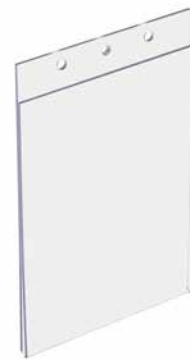

### Poster Holder (simple or adhesive)

- Manufactured in PS with diamond polished edges
- Transparent for optimum visibility of the inserted message
- Double sided for maximum impact and space optimization on all angles
- Works with a variety of adhesives to stick on different surfaces (provided per request)

Item Code	Description (Paper Format & Orientation)	Thickness (mm)	Units / Box
SP10924STY	A6 Portrait Poster Holder	1,5	30
SP10923STY	A6 Landscape Poster Holder	1,5	30
SP10835STY	A5 Portrait Poster Holder	1,5	25
SP10925STY	A5 Landscape Poster Holder	1,5	25
SP10836STY	A4 Portrait Poster Holder	1,5	20
SP10921STY	A4 Landscape Poster Holder	1,5	20
SP10927STY	A3 Portrait Poster Holder	2	15
SP10926STY	A3 Landscape Poster Holder	2	15





## POSTER POCKETS / SLEEVES

Our range of self-adhesive poster pockets offers permanent protection against dust, dirt and water. Only a few seconds to slide in a new display, no need to remove the holder from the wall, shelf or display bin. The slide-in pockets are specifically designed for wall mounting posters, information sheets, product specifications and directions. These pockets feature 2 self-adhesive back strips for attachment to all smooth surfaces, and can be removed without leaving residue behind. They are manufactured from high quality PET, making them break/shatterproof, lighter and more flexible compared to materials like PS and PMMA. Present important information in an attractive way with a simple and colorless construction that makes these items the perfect addition to any environment. They are cost-effective and come in a wide variety of sizes, both portrait and landscape.

### Adhesive Pockets / Ticket Holder

- Manufactured in PET available in Clear or Anti-glare
- Display information with the space-saving PET Ticket Holder - just vertical foot-print
- Sticks easily to all smooth surfaces with the pre-installed adhesive tape strips
- Break- and shatter-proof; lighter, more flexible compared to other materials like PS or PMMA

#### Clear

Item Code	Description (Paper Format & Orientation)	Thickness (mm)	Units / Box
SV11279ADH	A7 Portrait Adhesive Pocket	0,3	200
SV11280ADH	A7 Landscape Adhesive Pocket	0,3	200
SV10234ADH	A6 Portrait Adhesive Pocket	0,3	200
SV11281ADH	A6 Landscape Adhesive Pocket	0,3	200
SV10235ADH	A5 Portrait Adhesive Pocket	0,3	200
SV11264ADH	A5 Landscape Adhesive Pocket	0,4	200
SV10236ADH	A4 Portrait Adhesive Pocket	0,3	100
SV11221ADH	A4 Landscape Adhesive Pocket	0,4	100
SV11225ADH	A3 Portrait Adhesive Pocket	0,5	50
SV11282ADH	A3 Landscape Adhesive Pocket	0,5	50



#### Anti-Glare

Item Code	Description (Paper Format & Orientation)	Thickness (mm)	Units / Box
SV11279ADHAR	A7 Portrait Adhesive Pocket AR	0,3	200
SV11280ADHAR	A7 Landscape Adhesive Pocket AR	0,3	200
SV10234ADHAR	A6 Portrait Adhesive Pocket AR	0,3	200
SV11281ADHAR	A6 Landscape Adhesive Pocket AR	0,3	200
SV10235ADHAR	A5 Portrait Adhesive Pocket AR	0,3	200
SV11264ADHAR	A5 Landscape Adhesive Pocket AR	0,3	200
SV10236ADHAR	A4 Portrait Adhesive Pocket AR	0,3	100
SV11221ADHAR	A4 Landscape Adhesive Pocket AR	0,3	100
SV11225ADHAR	A3 Portrait Adhesive Pocket AR	0,5	50
SV11282ADHAR	A3 Landscape Adhesive Pocket AR	0,4	50



## POSTER POCKETS / SLEEVES

Our range of magnetic poster pockets offers permanent protection against dust, dirt and water. Only a few seconds to slide in a new display, no need to remove the holder from the wall, shelf or display bin. The slide-in pockets are specifically designed for mounting posters, information sheets, product specifications and directions. These pockets feature 2 magnetic back strips for attachment to all metallic surfaces and can be removed without leaving residue behind. They are manufactured from high quality PET, making them break/shatterproof, lighter and more flexible compared to materials like PS and PMMA. Present important information in an attractive way with a simple and colorless construction that makes these items the perfect addition to any environment. They are cost-effective and come in a wide variety of sizes, both portrait and landscape.

### Magnetic Pockets / Ticket Holder

- Manufactured in PET available in Clear or Anti-glare
- Display information with the space-saving PET Ticket Holder - just vertical foot-print
- Sticks easily to all smooth surfaces with the pre-installed adhesive tape strips
- Break- and shatter-proof; lighter, more flexible compared to other materials like PS or PMMA

Item Code	Description (Paper Format & Orientation)	Thickness (mm)	Units / Box
SV11279MAG	A7 Portrait Magnetic Pocket	0,3	200
SV11280MAG	A7 Landscape Magnetic Pocket	0,3	200
SV10234MAG	A6 Portrait Magnetic Pocket	0,3	200
SV11281MAG	A6 Landscape Magnetic Pocket	0,3	200
SV10235MAG	A5 Portrait Magnetic Pocket	0,3	200
SV11264MAG	A5 Landscape Magnetic Pocket	0,4	200
SV10236MAG	A4 Portrait Magnetic Pocket	0,3	100
SV11221MAG	A4 Landscape Magnetic Pocket	0,4	100
SV11225MAG	A3 Portrait Magnetic Pocket	0,5	50
SV11282MAG	A3 Landscape Magnetic Pocket	0,5	50

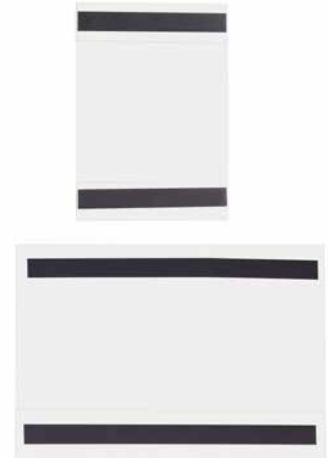

Item Code	Description (Paper Format & Orientation)	Thickness (mm)	Units / Box
SV11279MAGAR	A7 Portrait Magnetic Pocket AR	0,3	200
SV11280MAGAR	A7 Landscape Magnetic Pocket AR	0,3	200
SV10234MAGAR	A6 Portrait Magnetic Pocket AR	0,3	200
SV11281MAGAR	A6 Landscape Magnetic Pocket AR	0,3	200
SV10235MAGAR	A5 Portrait Magnetic Pocket AR	0,3	200
SV11264MAGAR	A5 Landscape Magnetic Pocket AR	0,3	200
SV10236MAGAR	A4 Portrait Magnetic Pocket AR	0,3	100
SV11221MAGAR	A4 Landscape Magnetic Pocket AR	0,3	100
SV11225MAGAR	A3 Portrait Magnetic Pocket AR	0,5	50
SV11282MAGAR	A3 Landscape Magnetic Pocket AR	0,4	50



## POSTER POCKETS / SLEEVES

Our range of perforated poster pockets offers permanent protection against dust, dirt and water. Fully transparent and double sided, the pockets offer the optimum visibility, drawing attention to the inserted messages and / or images. Only a few seconds to slide in a new display. The slide-in pockets are specifically designed for hanging posters, information sheets, product specifications and directions. They are manufactured from high quality PET, making them break/shatterproof, lighter and more flexible compared to materials like PS and PMMA. Present important information in an attractive way with a simple and colorless construction that makes these items the perfect addition to any environment. They are cost-effective and come in a wide variety of sizes, both portrait and landscape.

### Poster Pocket / Ticket Holder with Holes

- Manufactured in PET available in Clear or Anti-glare
- PET Poster Holder for directional signage or promotional banners
- U-Shaped pocket allowing easy and quick poster replacement
- Break and shatter-proof; lighter, more flexible compared to other materials like PS or PMMA

#### Clear

Item Code	Description (Paper Format & Orientation)	Thickness (mm)	Units / Box
SV11564	A6 Portrait Perforated Pocket	0,3	200
SV11229	A5 Portrait Perforated Pocket	0,4	200
SV11226	A4 Portrait Perforated Pocket	0,4	100
SV11231	A4 Landscape Perforated Pocket	0,4	100

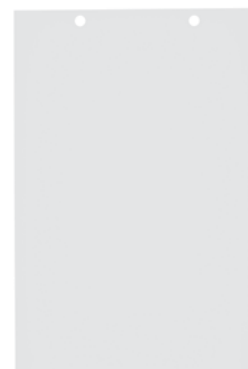

#### Anti-Glare

Item Code	Description (Paper Format & Orientation)	Thickness (mm)	Units / Box
SV11564AR	A6 Portrait Perforated Pocket AR	0,3	200
SV11229AR	A5 Portrait Perforated Pocket AR	0,4	200
SV11226AR	A4 Portrait Perforated Pocket AR	0,4	100
SV11231AR	A4 Landscape Perforated Pocket AR	0,4	100

### Poster Pocket / Ticket Holder with Eyelets

- Manufactured in Anti-Glare PET
- PET Poster Holder for directional signage or promotional banners
- Comes complete with eyelets for instant hanging
- Break and shatter-proof; lighter, more flexible compared to other materials like PS or PMMA

#### Anti-Glare

Item Code	Description (Paper Format & Orientation)	Thickness (mm)	Units / Box
SV12189AR	A4 Portrait PET Poster Pocket with Eyelets	0,3	50
SV12188AR	A3 Portrait PET Poster Pocket with Eyelets	0,3	50
SV12190AR	A3 Portrait PET Poster Pocket with Eyelets	0,4	50
SV12187AR	A2 Portrait PET Poster Pocket with Eyelets	0,4	20
SV12184AR	A1 Portrait PET Poster Pocket with Eyelets	0,4	10

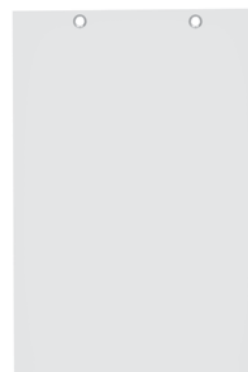

## WRITE-ON RANGE

Draw attention and present your information in your own design: the high-quality, black table display chalk board style is ideal for individual labelling and design. A bold black background provides contrast to white or brightly colored writing so the label is easy to read, even from a distance! When you're done, it can easily be cleaned with a wet cloth so that you're ready to use it again and again. "Ready to use" no assembly required.

### L-Shaped Write-on Menu

- No matter the use and the environment, this single-sided sign will elegantly display information
- Easily stays upright due to built-in support

Item Code	Description (Display Format)	Thickness (mm)	Units / Box
<b>W00001</b>	A6 Portrait Write-On Menu	2 mm	20
<b>W00002</b>	A5 Portrait Write-On Menu	2 mm	30
<b>W00003</b>	A4 Portrait Write-On Menu	2 mm	30
<b>W00004</b>	A3 Portrait Write-On Menu	2 mm	20



### T-Shaped Write-on Table Menu

- This double-sided sign with wood base will elegantly display information in any environment

Item Code	Description (Display Format)	Thickness (mm)	Units / Box
<b>W00005BOIS</b>	A6 Portrait Write-On Menu with Wood Base	2 mm	20
<b>W00006BOIS</b>	A5 Portrait Write-On Menu with Wood Base	2 mm	20
<b>W00007BOIS</b>	A4 Portrait Write-On Menu with Wood Base	2 mm	10
<b>W00008BOIS</b>	A3 Portrait Write-On Menu with Wood Base	2 mm	3



### A-Shaped Write-on Table Number

- No matter the use and environment, this double-sided sign will elegantly display information

Item Code	Description (Display Length x Height cm)	Thickness (mm)	Units / Box
<b>W00027</b>	10 x 5 cm Write-On Label	2 mm	25
<b>W00028</b>	10 x 10 cm Write-On Label	2 mm	25





## WRITE-ON RANGE

Draw attention and present your information in your own design: the high-quality, black table display chalk board style is ideal for individual labelling and design. A bold black background provides contrast to white or brightly colored writing so the label is easy to read, even from a distance! When you're done, it can easily be cleaned with a wet cloth so that you're ready to use it again and again. "Ready to use" no assembly required.

### L-Shaped Write-on Label

- No matter the use and environment, this single-sided sign will elegantly display information
- Easily stays upright due to built-in support

Item Code	Description (Display Length x Height cm)	Thickness (mm)	Units / Box
W00021	5 x 4 cm Write-On Label	2 mm	50
W00022	6 x 4 cm Write-On Label	2 mm	50
W00023	7 x 5 cm Write-On Label	2 mm	50
W00024	8 x 6 cm Write-On Label	2 mm	50
W00025	10 x 7 cm Write-On Label	2 mm	30
W00026	12 x 8 cm Write-On Label	2 mm	30



### T-Shaped Write-on Label

- This double-sided sign with wood base will elegantly display information in any environment

Item Code	Description (Display Length x Height cm)	Thickness (mm)	Units / Box
W00029BOIS	5 x 4 cm Write-On Label	2 mm	30
W00030BOIS	6 x 4 cm Write-On Label	2 mm	30
W00031BOIS	7 x 5 cm Write-On Label	2 mm	30
W00032BOIS	8 x 6 cm Write-On Label	2 mm	30
W00033BOIS	10 x 7 cm Write-On Label	2 mm	20
W00034BOIS	12 x 8 cm Write-On Label	2 mm	20



### Write-on Tags

- Black in colour on both sides, these labels can be used with erasable or permanent chalk pens.
- Compatible with our T-Shaped Write-On Label base and also for use as is
- Sold in sets of 10 units

Item Code	Description (Display Length x Height cm)	Thickness (mm)	Units / Box
W00035	7.4 x 5.2 cm - Format A8	2 mm	50
W00036	8.5 x 5 cm	2 mm	50
W00037	10.5 x 7.4 cm - Format A7	2 mm	50





# INJECTION RANGE

Our brochure holder range is made of durable materials, resistant to scrapes, and it won't damage your surfaces and countertops. The items are see-through, allowing people to view the brochures, trifolds, pamphlets, catalogs and booklets easily from afar as well as perfectly integrating in any environment. Additionally, it is lightweight and can be transferred from place to place with minimal effort. These Marketing Holders are perfect for Trade Shows, Expos or any Event. It is self-standing, so you don't need anything else to set it securely on a flat surface. You can effortlessly slide brochures and booklets in and out of this acrylic container.

## Premium Range

### Business Card Holder

- Manufactured in clear durable acrylic.
- Transparent for optimum visibility of the leaflet and perfect integration
- Slanted for optimum visibility even when used bellow eye level



Item Code	Description (Width x Depth x Overall Height mm)	Units / Box
IN000006	Business Card Holder 104 x 52 x H 62 mm	10

### 1 Compartment Brochure / Leaflet Holder

- Manufactured in clear durable acrylic.
- Transparent for optimum visibility of the leaflet and perfect integration
- Slanted for optimum visibility even when used bellow eye level



Item Code	Description (Width x Depth x Overall Height mm)	Units / Box
IN000003	1/3 A4 Portrait Leaflet Holder - 117 x 101 x H 195 mm	5
IN000002	A5 Portrait Leaflet Holder - 173 x 101 x H 197 mm	5
IN000001	A4 Portrait Leaflet Holder - 237 x 120 x H 283 mm	5

### 3 Compartments Brochure / Leaflet Holder

- Manufactured in clear durable acrylic.
- Transparent for optimum visibility of the leaflet and perfect integration
- Slanted for optimum visibility even when used bellow eye level



Item Code	Description (Width x Depth x Overall Height mm)	Units / Box
IN000004	A4 Portrait Leaflet Holder - 237 x 182 x H 357 mm	5

### 4 Compartments Brochure / Leaflet Holder

- Manufactured in clear durable acrylic.
- Transparent for optimum visibility of the leaflet and perfect integration
- Slanted for optimum visibility even when used bellow eye level



Item Code	Description (Width x Depth x Overall Height mm)	Units / Box
IN000005	1/3 A4 Portrait Leaflet Holder - 115 x 184 x H 265 mm	5



## INJECTION RANGE

Our brochure holder range is made of durable materials, resistant to scrapes, and it won't damage your surfaces and countertops. The items are see-through, allowing people to view the brochures, trifold, pamphlets, catalogues and booklets easily from afar as well as perfectly integrating in any environment. Additionally, it is lightweight and can be transferred from place to place with minimal effort. These Marketing Holders are perfect for Trade Shows, Expos or any Event. It is self-standing, so you don't need anything else to set it securely on a flat surface. You can effortlessly slide brochures and booklets in and out of this acrylic container.

### Classic Range

#### Business Card Holder

- Manufactured in clear durable acrylic.
- Transparent for optimum visibility of the contents
- Slanted for optimum visibility even when used bellow eye level

Item Code	Description	Units / Box
IN000016	1 Compartment	120
IN000026	4 Compartments	72
IN000027	8 Compartments	36



#### 1 Compartment Brochure / Leaflet Holder

- Manufactured in clear durable acrylic.
- Transparent for optimum visibility of the leaflet and perfect integration
- Slanted for optimum visibility even when used bellow eye level

Item Code	Description	Units / Box
IN000019	1/3 A4 Portrait Leaflet (no hanging holes)	5
IN000018	A5 Portrait Leaflet (with hanging holes)	5
IN000017	A4 Portrait Leaflet (with hanging holes)	5



#### 3 Compartments Brochure / Leaflet Holder

- Manufactured in clear durable acrylic.
- Transparent for optimum visibility of the leaflet and perfect integration
- Slanted for optimum visibility even when used bellow eye level

Item Code	Description	Units / Box
IN000022	3 x 1/3 A4 Portrait Leaflet	5
IN000020	3 x A4 Portrait Leaflet	5

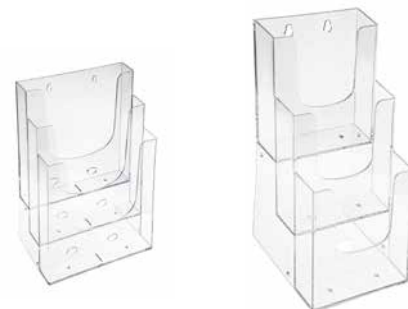

#### 4 Compartments Brochure / Leaflet Holder

- Manufactured in clear durable acrylic.
- Transparent for optimum visibility of the leaflet and perfect integration
- Slanted for optimum visibility even when used bellow eye level

Item Code	Description	Units / Box
IN000021	4 x 1/3 A4 Portrait Leaflet	5





## LEAFLET HOLDERS

Our brochure holder range is made of durable materials, resistant to scrapes, and it won't damage your surfaces and counter-tops. The items are see-through, allowing people to view the brochures, trifold, pamphlets, catalogs and booklets easily from afar as well as perfectly integrating in any environment. Additionally, it is lightweight and can be transferred from place to place with minimal effort. These Marketing Holders are perfect for Trade Shows, Expos or any Event. It is self-standing, so you don't need anything else to set it securely on a flat surface. You can effortlessly slide brochures and booklets in and out of this acrylic container.

### Product Support Stand / Easel "Premium" Range

- Manufactured in PMMA with diamond polished edges.
- Transparent for optimum visibility of the leaflet and perfect integration
- This display stand comes complete with a protective lip to stop product from sliding

Item Code	Description (Paper Format & Orientation)	Thickness (mm)	Units / Box
SP10928	Slanted Leaflet Holder for A6 Landscape Format	2	25
SP10917	Slanted Leaflet Holder for A6 Portrait Format	2	25
SP10918	Slanted Leaflet Holder for A5 Portrait Format	2	20
SP10929	Slanted Leaflet Holder for A4 Portrait Format	2	10



### Product / Leaflet Stand / Easel

- Manufactured in PS with diamond polished edges
- Transparent for optimum visibility of the leaflet and perfect integration
- This display stand comes complete with a protective lip to stop product from sliding

Item Code	Description (Paper Format & Orientation)	Thickness (mm)	Units / Box
SV11971STY	Slanted Leaflet Holder for A6 Portrait Format	3	20
SV10056STY	Slanted Leaflet Holder for 1/3 A4 Portrait Format	3	20
SV10057STY	Slanted Leaflet Holder for A5 Portrait Format	3	20
SV10058STY	Slanted Leaflet Holder for A4 Portrait Format	3	20



### Multisurface Leaflet Holder

- Manufactured in PET
- Transparent for optimum visibility of the leaflet and perfect integration
- This brochure holder comes ready for installing either with screws or with adhesive tape

#### Wall-Mounting

Item Code	Description (Paper Format & Orientation)	Thickness (mm)	Units / Box
SV10294PET	Leaflet Holder for A6 Portrait Format	2	20
SV10292PET	Leaflet Holder for 1/3 A4 Portrait Format	2	20
SV10293PET	Leaflet Holder for A5 Portrait Format	2	20
SV10291PET	Leaflet Holder for A4 Portrait Format	2	20



#### Adhesive Tape Mounting

Item Code	Description (Paper Format & Orientation)	Thickness (mm)	Units / Box
SV10294ADHPET	Leaflet Holder for A6 Portrait Format	2	20
SV10292ADHPET	Leaflet Holder for 1/3 A4 Portrait Format	2	20
SV10293ADHPET	Leaflet Holder for A5 Portrait Format	2	20
SV10291ADHPET	Leaflet Holder for A4 Portrait Format	2	20



## LEAFLET DISPENSER / FLOOR STAND

Literature racks and freestanding brochure stands are needed for professional brochure display at exhibitions and trade shows. They are also used in reception areas, foyers, showrooms and libraries. Leaves the room free of magazine mayhem. The items are see-through, allowing people to view the brochures, trifold, pamphlets, catalogs and booklets easily from afar as well as perfectly integrating in any environment.

### Zig-Zag Brochure Stand

- Manufactured in PMMA with diamond polished edges
- Double sided Magazine Zig Zag Brochure Display Stand with compact base
- The stand is designed for standard brochures, catalogues or magazines as well as A4 prints.
- Delivered in flat pack with instructions for quick and easy building

Item Code	Description (Overall Height cm)	Thickness (mm)	Units / Box
MB80004	Zig-Zag Brochure Dispenser H 100 cm	6 & 10	1
MB80005	Zig-Zag Brochure Dispenser H 150 cm	6 & 10	1



### Zig-Zag Brochure Stand Wood Mix

- Manufactured in PMMA and wood with diamond polished edges
- Double sided Magazine Zig Zag Brochure Display S
- The stand is designed for standard brochures, catalogues as well as A4 prints

Item Code	Description (Overall Height cm)	Thickness (mm)	Units / Box
MB80005-BOIS	Zig-Zag Dispenser H 150 cm with Clear Sides	10	1

### 4 Levels Brochure Dispenser

- Manufactured in PMMA with diamond polished edges
- The stand is designed for standard brochures, catalogues or magazines as well as A4 prints.
- Delivered in flat pack with instructions for quick and easy building

Item Code	Description	Thickness (mm)	Units / Box
MB80276	4 Levels Dispenser for A4 Landscape Leaflets H 95cm	4 & 6	1
MB80286	4 Levels Dispenser for A4 Portrait Leaflets H 95cm	4 & 6	1



### Newspaper Leaflet Dispenser Stand

- Manufactured in PMMA with diamond polished edges
- The stand is designed for standard brochures, catalogues or magazines
- Delivered in flat pack with instructions for quick and easy building

Item Code	Description (Length x Depth x Height cm)	Thickness (mm)	Units / Box
MB80003	Newspaper Stand L 60 x D 40 x H 130 cm	6 & 10	1



### Raised Visual Holder

- Manufactured in PMMA with diamond polished edges
- The stand is designed for A4 leaflets, visual inserts
- Designed at the perfect viewing angle for passing customers

#### "Eco" Range

Item Code	Description (Poster Format & Overall Height cm)	Thickness (mm)	Units / Box
SV12293	A4 Portrait Raised Poster Holder H 90 cm	5	5

#### "Premium" Range

Item Code	Description (Poster Format & Overall Height cm)	Thickness (mm)	Units / Box
SV10044 + SV10046	A4 Portrait Raised Poster Holder H 90 cm	3 & 6	10





## PRESENTATION DISPLAYS

This clear acrylic lectern range features a simple yet sleek design that's sure to draw attention and keep your next presentation running smoothly! The podium provides a contemporary look that seamlessly matches the decor of offices, churches, convention centers, and more. From hotels and restaurants to banquet halls, retail shops and doctors' offices, these items are a must-have in virtually any business.

### Counter Lectern with Binder

- Manufactured in PS with diamond polished edges
- Transparent for optimum visibility of the leaflet and perfect environment integration
- The stand is designed for standard brochures, catalogues or magazines
- Display brochures or pages in a simple and easy to use manner on your chosen surface

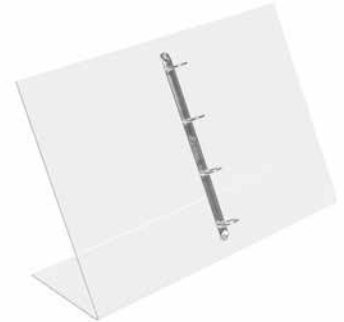

Item Code	Description (Paper Display Format & Orientation)	Thickness (mm)	Units / Box
AG21178STY	Lectern with Binder for 2 x A5 Portrait Posters	3	5
AG20562STY	Lectern with Binder for 2 x A4 Portrait Posters	3	5

### Free Standing Lectern - Wood Mix

- Manufactured in PMMA with diamond polished edges and wood
- A mix of clear and wood with perfect environment integration capacity.
- Free Standing A4 Lectern for two A4 displays

#### Version Y

Item Code	Description (Poster Format & Overall Height cm)	Units / Box
MB80002BOIS-L	2 x A4 Lectern; H 110 cm	1

#### Version Z

Item Code	Description (Poster Format & Overall Height cm)	Units / Box
MB80002BOIS-M	2 x A4 Lectern; H 110 cm	1



### Free Standing Lectern

- Manufactured in PMMA with diamond polished edges
- Free Standing A4 Lectern for two A4 displays

Item Code	Description (Overall Height cm)	Thickness (mm)	Units / Box
MB80002	① Free standing 2 x A4 Lectern H 110 cm – Clear	6 & 10	1
MB80306	② Foldable Base 2 x A4 Lectern H 115 cm - Clear	6	1
MB80297	③ Z-Shape 2 x A4 Lectern H 122 cm – Clear	8 & 10	1
MB80298	④ Rounded 2 x A4 Lectern H 120 cm – Clear	10	1



①



②



③



④



## SUGGESTION / DONATION BOXES

Lockable boxes, great for donations, ballots at school board, suggestions from customers or employees in any business environment. Durable, lightweight and transparent for perfect environment integration. See-through allowing you to see when the box is full so it can be emptied to make room for additional material. The lock ensures that the contents are safe and secure, provided with a set of two keys.

### Square Suggestion Box

- Manufactured in PMMA with diamond polished edges
- Lockable using the provided set of 2 keys and hinged cover

Item Code	Description (Sizes)	Thickness (mm)	Units / Box
MB80291	Square urn with lock 15 x 15 cm	3	1
MB80258	Square urn with lock 20 x 20 cm	3 & 4	1
MB80008	Square urn with lock 25 x 25 cm	3 & 4	1
MB80109	Square urn with lock 30 x 30 cm	3 & 4	1



### Suggestion Box with Poster Holder

- Manufactured in PMMA with diamond polished edges
- Trapeze or Square Shaped for paper insertion / voting
- Lockable using the provided set of 2 keys and hinged cover

Item Code	Description (Sizes)	Thickness (mm)	Units / Box
MB80013	Trapeze Dono Box 29 x 22 x 47 cm	2,5 & 4	1
MB80023	Square Dono Box 20 x 20 x 38 cm (with lock)	2,5 & 3 & 4	1
MB80301	Square Dono Box 21 x 21 x 21 cm	2 & 3 & 4	1



### Small Suggestion Box with Poster Holder

- Manufactured in PMMA with diamond polished edges
- Trapeze or Square Shaped for paper insertion / voting
- Lockable using the provided set of 2 keys and hinged cover

Item Code	Description (Box Sizes & Poster Paper Format)	Thickness (mm)	Units / Box
SP10644	Box 11 x 9 x 9 & Vertical A6 Portrait	2 & 3 & 5	2
MB80017	Box 15 x 10,5 x 10 & Slanted A6 Landscape	2,5 & 4	2



### Removable Lid Suggestion Box

- Manufactured in PMMA with diamond polished edges
- Removable top lid with seamless positioning

Item Code	Description (Sizes)	Thickness (mm)	Units / Box
MB80294	Square Dono Box 21 x 21 x 21 cm	3	1



## SUGGESTION / DONATION BOXES

Lockable boxes, great for donations, ballots at school board, suggestions from customers or employees in any business environment. Durable, lightweight and transparent for perfect environment integration. See-through allowing you to see when the box is full so it can be emptied to make room for additional material. The lock ensures that the contents are safe and secure, provided with a set of two keys.

### Ballot Box with Aluminium Frame (with / without content counter)

- Manufactured in Clear PMMA with structure in anodized aluminium
- Mechanical counter with security shutter. Reset wheel inside the cover.
- Secured via two separate locks
- The ballot box allows you to organize an election with rigor and professionalism
- This urn is available in two models: economic (without meter), or premium with meter

Item Code	Description (Sizes)	Thickness (mm)	Units / Box
MB80305ALU-S	Voting urn 30 x 30 x 25 cm (no content counter) – 22 liters	3	1
MB80302ALU-S	Voting urn 40 x 40 x 30 cm (no content counter) – 48 liters	3	1
MB80305ALU	Voting urn 30 x 30 x 25 cm (with counter) – 22 liters	3	1
MB80302ALU	Voting urn 40 x 40 x 30 cm (with counter) – 48 liters	3	1
MB80303ALU	Voting urn 40 x 40 x 40 cm (with counter) – 64 liters	3	1
MB80304ALU	Voting urn 50 x 50 x 45 cm (with counter) – 112 liters	3	1



### Ballot Box (with / without content counter)

- Manufactured in Clear PET
- Very resistant, this urn is transparent on all its faces.
- Secured via two separate locks.
- The ballot box allows you to organize an election with rigor and professionalism
- Ideal for elections, in town hall, associations, communities.
- This urn is available in two models: economic (without meter), or premium with meter.

Item Code	Description (Sizes)	Thickness (mm)	Units / Box
MB80305PET-S	Voting urn 30 x 30 x 25 cm (no content counter) – 22 liters	3	1
MB80302PET-S	Voting urn 40 x 40 x 30 cm (no content counter) – 48 liters	3	1
MB80305PET	Voting urn 30 x 30 x 25 cm (with counter) – 22 liters	3	1
MB80302PET	Voting urn 40 x 40 x 30 cm (with counter) – 48 liters	3	1
MB80303PET	Voting urn 40 x 40 x 40 cm (with counter) – 64 liters	3	1
MB80304PET	Voting urn 50 x 50 x 45 cm (with counter) – 112 liters	3	1



### Suggestion Box for Voting (Safety Seal Ready)

- Manufactured in PET
- Lockable using safety seals (not provided)

Item Code	Description (Sizes)	Thickness (mm)	Units / Box
MB80271PET	Dono Box 25 x 25 x 25 cm	3	1
MB80272PET	Dono Box 32 x 32 x 32 cm	3	1
MB80273PET	Dono Box 40 x 40 x 40 cm	3	1
MB80274PET	Dono Box 50 x 50 x 50 cm	3	1



### Free Standing Raised Donation / Suggestion Box

- Manufactured in PMMA with diamond polished edges
- Detachable foot for box counter usage, delivered with easy to install instructions

Item Code	Description (Sizes and Overall Height cm)	Thickness (mm)	Units / Box
MB80138	Dono Box 25 x 25 x 25 cm; Foot Height 65 cm	3 & 4 & 8	1
MB80138BOIS	Dono Box 25 x 25 x 25 cm; Food Height 65 cm Wood Base	3	1



## PRODUCT HOLDERS / EASELS

Easels are a retail essential that has a variety of display capabilities. This quality holder is produced from clear acrylic slightly slanted for a better product visibility when used below eye level and has rounded corners for safety. The easel is suitable for goods, slide show on counters, shelves, in cabinets and display windows. Our clear range is ideal for displaying books, mobile phones, iPods or ornaments that need a support.

### Product Support Stand / Easel "Classic" Range

- Manufactured in PS with diamond polished edges
- Designed at the perfect viewing angle for passing customers
- This display stand comes complete with a protective lip to stop your product from sliding off

Item Code	Description	Thickness (mm)	Units / Box
AG20013STY	Easel - 3,5 cm Product Depth (4 x 5 x 5)	3	100
AG20038STY	Easel - 3,5 cm Product Depth (4 x 5 x 10)	3	100
AG20122	Easel - 3 cm Product Depth (4 x 9 x 10)	3	50
AG20124	Easel - 6 cm Product Depth (5 x 15 x 20)	3	50
AG20039STY	Easel - 3,5 cm Product Depth (6 x 7,5 x 15)	3	100
AG20123	Easel - 7 cm Product Depth (7 x 10 x 15)	3	100
AG20015STY	Easel - 4 cm Product Depth (8 x 12 x 20)	3	30
AG21187	Easel - 3 cm Product Depth (8 x 10 x 12)	3	50



### Product Support Stand / Easel "Premium" Range

- Manufactured in PMMA with diamond polished edges
- Designed at the perfect viewing angle for passing customers
- This display stand comes complete with a protective lip to stop your product from sliding

Item Code	Description	Thickness (mm)	Units / Box
SP10962	Easel "S" – L 30 x D 83 x H 52 mm	2	30
SP10950	Easel "M" – L 75 x D 100 x H 100 mm	2	10
SP10951	Easel "L" – L 100 x D 110 x H 150 mm	3	10
SP10952	Easel "XL" – L 100 x D 150 x H 200 mm	3	10



### Triangle Product Support Stand / Easel

- Manufactured in PS with diamond polished edges
- Designed at the perfect viewing angle for passing customers
- This display stand comes complete with a protective lip to stop your product from sliding off

Item Code	Description	Thickness (mm)	Units / Box
AG20020	Triangle Easel - 3,5 cm Product Depth (4 x 14 x 13)	2	30



### Quick Set-up Easel

- Manufactured in PS
- Designed at the perfect viewing angle for passing customers
- This display stand is delivered as a flat pack

Item Code	Description	Thickness (mm)	Units / Box
AG20046	Product Easel - 3,5 Max. Product Depth (5 x 10)	3	100





## PRESENTATION BOXES

Products made of clear acrylic (PMMA), giving you the ability to see what's inside while not skimping on sturdiness. Boxes are great for display or storage - use them as dump bins with loose items, or keep supply closets organized. Combine multiple boxes to easily create custom display areas. "Ready to use" no assembly required.

### Multi-Usage Storage Tube/ Round Box

- Manufactured in Clear PMMA
- Versatile clean and sleek design allowing customers to easily view the items on display
- Diamond polished edges



### Round / Tube Box

Item Code	Description (Diameter x Overall Height cm)	Thickness (mm)	Units / Box
AG21160PA	Round Box Ø 10 x H 10 cm	3 mm	4
AG21159PA	Round Box Ø 12 x H 10 cm	3 mm	4
AG21158PA	Round Box Ø 12 x H 15 cm	3 mm	4
AL60429PA	Round Box Ø 12 x H 20 cm	3 mm	4
AL60418PA	Round Box Ø 12 x H 30 cm	3 mm	4
AG21161PA	Round Box Ø 15 x H 10 cm	3 mm	4
AG21157PA	Round Box Ø 15 x H 15 cm	3 mm	4
AL60007PA	Round Box Ø 15 x H 20 cm	3 mm	1
AL60006PA	Round Box Ø 15 x H 30 cm	3 mm	1
AL60430PA	Round Box Ø 15 x H 40 cm	3 mm	1
AL60431PA	Round Box Ø 20 x H 10 cm	3 mm	4
AG21156PA	Round Box Ø 20 x H 15 cm	3 mm	4
AG21191PA	Round Box Ø 20 x H 20 cm	3 mm	1
AL60433PA	Round Box Ø 20 x H 30 cm	3 mm	1
AL60434PA	Round Box Ø 20 x H 40 cm	3 mm	1

### Square / Rectangle Box

Item Code	Description (Length x Depth x Height cm)	Thickness (mm)	Units / Box
AG20959PA	Box L 7,5 x D 7,5 x H 5 cm	3 mm	8
AG20962PA	Box L 22 x D 16 x H 5 cm	3 mm	4
AG21258PA	Box L 7,5 x D 7,5 x H 10 cm	3 mm	8
AG20961PA	Box L 10 x D 10 x H 10 cm	3 mm	4
AG21149PA	Box L 12 x D 12 x H 10 cm	3 mm	8
AG21150PA	Box L 15 x D 15 x H 10 cm	3 mm	8
AG20960PA	Box L 20 x D 20 x H 10 cm	3 mm	8
AG20965PA	Box L 30 x D 22 x H 10 cm	3 mm	4
AL60275PA	Box L 50 x D 15 x H 12 cm	3 mm	2
AG20964PA	Box L 7,5 x D 7,5 x H 15 cm	3 mm	8
AG21154PA	Box L 20 x D 10 x H 15 cm	3 mm	8
AG21155PA	Box L 20 x D 30 x H 15 cm	3 & 4 mm	4
AG21153PA	Box L 30 x D 30 x H 15 cm	3 & 4 mm	4
AG21151PA	Box L 15 x D 15 x H 20 cm	3 mm	4
AG21152PA	Box L 20 x D 20 x H 20 cm	3 mm	4

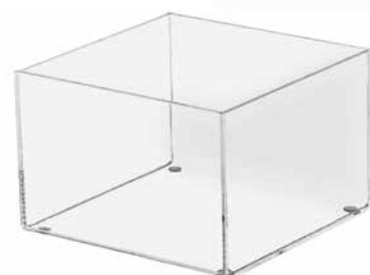





## DUMP BINS / IMPULSE BOXES

Our range of dump bins is manufactured in high quality acrylics and offer a versatile, economical and durable option for storage. Customers love a rummage and well placed dump bins can bring impulse buys. The see-through concept allows for a perfect visibility of the contents showcasing your products as well as perfect environment integration. Combine multiple boxes to easily create custom display areas. The clear simple and sturdy design provides a raised position for small items to be mixed while saving floor space due to its small footprint.

### Bulk Bin

- Manufactured in PMMA with diamond polished edges
- Transparent for perfect environment integration
- Sold with 4 removable poster holders: 2 x A4 Portrait and 2 x A5 Portrait to be placed by customer

Item Code	Description (Size & Overall Height cm)	Thickness (mm)	Units / Box
AG21188	Dump Bin 30 x 30 x H 90 cm - "Classic"	4	1
SP10335	Dump Bin 30 x 30 x H 90 cm - "Premium"	6	1



### Glass-Look Bulk Bin

- Manufactured in Glass-Look PMMA with diamond polished edges
- Transparent for perfect environment integration with Glass-Look finish for an original feel

Item Code	Description (Size & Overall Height cm)	Thickness (mm)	Units / Box
SP10208GL	Dump Bin 30 x 30 x H 90 cm - "Glass-Look"	4	1



### Anti-Shock Bulk Bin

- Manufactured in PET
- Transparent for perfect environment integration
- Shock resistant
- Increased fire resistance
- Food contact certified

Item Code	Description (Size & Overall Height cm)	Thickness (mm)	Units / Box
AG21302PETG	Dump Bin 29 x 29 x H 90 cm	4	1



## DUMP BINS / IMPULSE BOXES

Our range of dump bins is manufactured in high quality acrylics and offer a versatile, economical and durable option for storage. Customers love a rummage and well placed dump bins can bring impulse buys. The see-through concept allows for a perfect visibility of the contents showcasing your products as well as perfect environment integration. Combine multiple boxes to easily create custom display areas. The clear simple and sturdy design provides a raised position for small items to be mixed while saving floor space due to its small footprint.

### Bulk Bin Tube

- Manufactured in PMMA with diamond polished edges
- Transparent for perfect environment integration
- Sold with 1 A4 Portrait adhesive poster holder

Item Code	Description (Diameter & Overall Height cm)	Thickness (mm)	Units / Box
AG21189	Dump Bin Ø 20 x H 100 cm	4	1



### Bulk Bin with White Metal Base and Poster Holder

- Manufactured in PMMA and Metal
- Transparent dump bin with white metal foot, raised A4 poster holder and small wheels
- Raised foot delivered disassembled with quick install guide
- Sold with 1 A4 Portrait poster holder

Item Code	Description (Diameter & Overall Height cm)	Thickness (mm)	Units / Box
AG21200+MET	Bulk Bin with White Metal Base Ø 60 x H 130 cm	2 & 3	1



### Collapsible Bulk Bin "Eco" Range

- Manufactured in PET
- Transparent for perfect environment integration collapsible for easy storage and transport cost optimization
- Shock resistant
- Increased fire resistance
- Food contact certified
- Delivered in flat pack with install guide for quick built

Item Code	Description (Diameter & Overall Height cm)	Thickness (mm)	Units / Box
AG21288PET	Puzzle Dump Bin 30 x 30 x H 90 cm	2	1





## PHOTO HOLDERS

Our range is manufactured in acrylic and is the perfect way to showcase your favorite photos. Produced in clear materials to ensure perfect environment integration so that your photos are the main focus. "Ready to use" no assembly required.

### L-Shape Photo Holders

- Transparent for optimum visibility of the photo and slanted for better visibility when used below eye level
- Photo insertion is possible from each side for easy replacement

### Classic Range

Manufactured in PS with diamond polished edges

Item Code	Description (Paper Insert Format)	Thickness (mm)	Units / Box
PH90223STY-S	L-Shape Photo Holder 10 x 15 - Portrait	1,2	10
PH90228STY-S	L-Shape Photo Holder 10 x 15 - Landscape	1,2	10
PH90224STY-S	L-Shape Photo Holder 13 x 18 - Portrait	1,2	10
PH90229STY-S	L-Shape Photo Holder 13 x 18 - Landscape	1,2	10
PH90225STY-S	L-Shape Photo Holder 15 x 21 - Portrait	1,2	5
PH90230STY-S	L-Shape Photo Holder 15 x 21 - Landscape	1,2	10
PH90226STY-S	L-Shape Photo Holder 18 x 24 - Portrait	1,2	10
PH90231STY-S	L-Shape Photo Holder 18 x 24 - Landscape	1,2	10
PH90305STY-S	L-Shape Photo Holder 20 x 25 - Portrait	1,2	10
PH90306STY-S	L-Shape Photo Holder 20 x 25 - Landscape	1,2	10
PH90232STY-S	L-Shape Photo Holder 20 x 30 - Portrait	1,2	10
PH90307STY-S	L-Shape Photo Holder 20 x 30 - Landscape	1,2	10



### Premium Range

Manufactured in PMMA with diamond polished edges

Item Code	Description (Paper Insert Format)	Thickness (mm)	Units / Box
PH90223	L-Shape Photo Holder 10 x 15 - Portrait	1,5	30
PH90228	L-Shape Photo Holder 10 x 15 - Landscape	1,5	30
PH90224	L-Shape Photo Holder 13 x 18 - Portrait	1,5	30
PH90229	L-Shape Photo Holder 13 x 18 - Landscape	1,5	30
PH90225	L-Shape Photo Holder 15 x 21 - Portrait	1,5	30
PH90230	L-Shape Photo Holder 15 x 21 - Landscape	1,5	30
PH90226	L-Shape Photo Holder 18 x 24 - Portrait	1,5	15
PH90231	L-Shape Photo Holder 18 x 24 - Landscape	1,5	15
PH90305	L-Shape Photo Holder 20 x 25 - Portrait	1,5	15
PH90306	L-Shape Photo Holder 20 x 25 - Landscape	1,5	15
PH90232	L-Shape Photo Holder 20 x 30 - Portrait	1,5	15
PH90307	L-Shape Photo Holder 20 x 30 - Landscape	1,5	15







## CONTACT DETAILS

- **S.C. PLEXIROM S.R.L.**
- Manufacturer of acrylic products
- Founded in 1994

**Headquarters**  
Strada Rodnei, no 66  
032918 București, Romania

[www.plexirom.com](http://www.plexirom.com)